

Coupe Watercolours

Painting is fast growing in popularity, but for new artists help is always useful and it is to those that this book is aimed.

# Painting In Watercolours With David Coupe

Watercolour painting is not easy, but its lots of fun, try it.

David Coupe

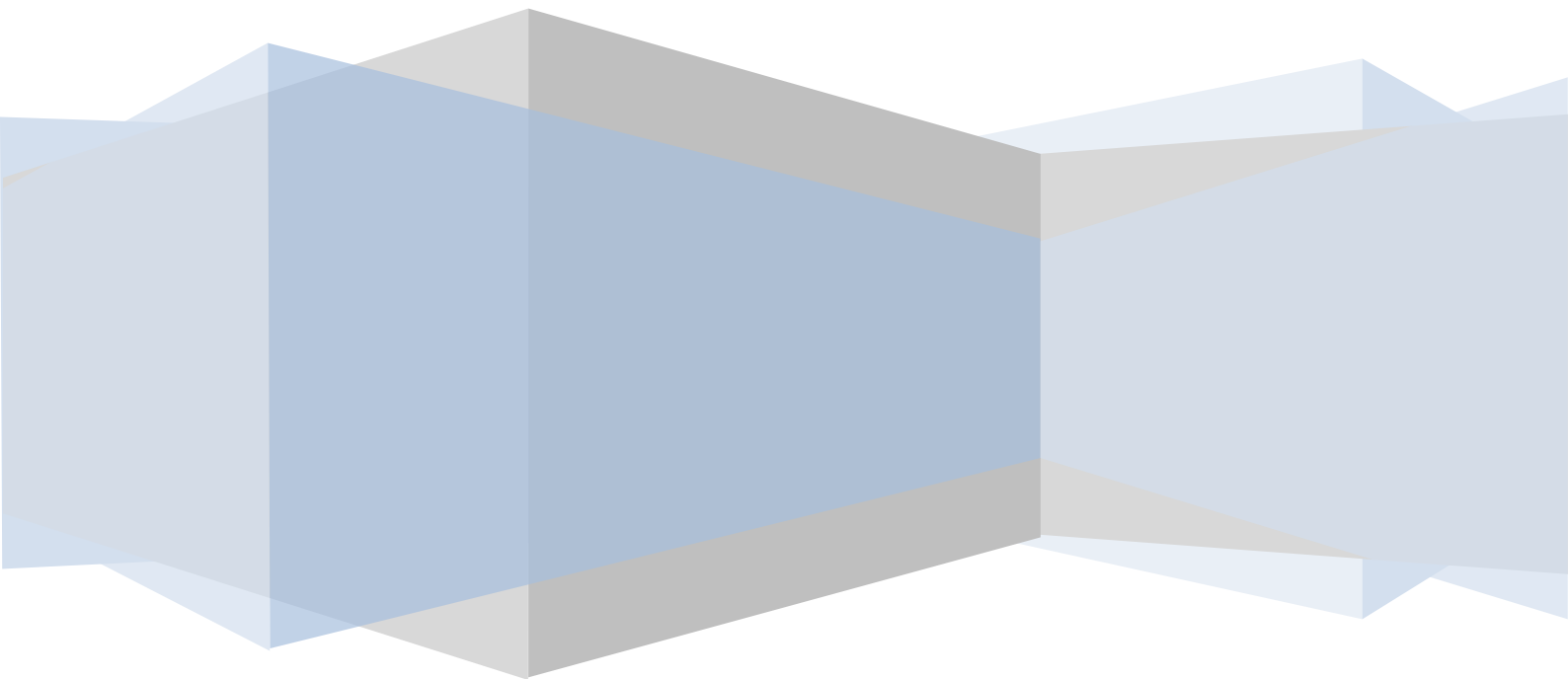



# LIST OF CONTENTS



## Page 6.....[Introduction](#)

in this chapter I go into people's attitude towards painting, the do's and don'ts when buying artist materials and the advantages of good quality materials over the cheaper ones.

## Page 22.....[Colour Mixing](#)

in this chapter I cover one of the biggest problems that the student has and that is mixing mud. It is one of those things that is very easy to avoid, and yet not many people take the time to find out what causes it.

Page 10 the colours that over the years I have put together to form my palette.

Page 20 what kind of brushes do we need.

Page 24 the colour wheel.

Page 25 the colour range

Page 26 what is mud.

Page 28 complementary colours.

Page 29 mixing secondary colours

Page 34 mixing a dark colour

Page 35 warm and cool colours and their uses.

## Page 37.....[Tone Control](#)

tone control is probably the most important part of watercolour painting and one that is sadly neglected by most people. Without a good tonal range in a painting the end product will look very flat and uninteresting. It is a very difficult thing to come to terms with, everybody understands what colour is about but not many people understand tone.

Page 37 how water is used with paint to adjust the tone.

Page 38 the tonal range.

Page 39 working with pencil to get a tonal sketch.

## Page 42.....[Perspective](#)

everybody's pet hate, perspective. It is a subject that people try to avoid but if you are going to get successful watercolours it is one that must be tackled. With a few basic rules perspective is not the horrible subject that many fear.

Working from the basics up will enable the student, if he encounters a problem in a piece of work, to correct the problem easily.

Page 42 using the angle finder.

Page 43 how to find the eye line.

Page 45 the vanishing points.

Page 46 Using buildings or walls to find the eye line.

Page 49 buildings going round a corner.

Page 51 out to show telegraph poles disappearing into the distance.

Page 54 putting a seat on a paved area.

Page 54 drawing a gable end.

Page 56 drawing a house above and below the eye line.

Page 57 from looking at perspective in a photograph.

Page 61 looking at perspective when the road runs downhill.

Page 62 looking at perspective when the road runs uphill

Page 66 drawing a circle.

Page 67 drawing a wheel attached to a building.

Page 68 fitting a porch to a building.

Page 69.....[The Key Measure](#)

this is a subject that many ignore totally and yet it can be very useful tool in your watercolour box. Whatever you see out in the landscape, no matter how vast, it will enable you to get it on your paper. It is a very useful tool that can be used in any form of art.

Page 69 how to use the skewer in getting the key measure and the importance of holding it correctly.

Page 70 organizing the view and setting the limits with a picture finder.

Page 71 using the key measure to draw a simple shape.

Page 72 using the key measure to get the proportions of a barn in a picture.

Page 72 building a sketch from a photograph using the key measure.

Page 80.....[Composition](#)

composition is one of those things that when talked about, much of it is common sense and can be very beneficial to your paintings. It is another one of those subjects full of mystique and it shouldn't be.

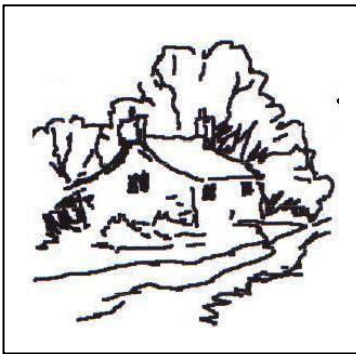

It is the aim of this book to cover the basics of watercolour painting. Without a good grounding you will never be happy with what you paint so it is very important for you to spend as much time as possible getting a good grounding in this wonderful yet frustrating medium. With watercolour painting it is truly a fact that practise makes perfect, so don't set your sights too high too quickly or you will not enjoy your painting. You will find that you will be your own worst critic. Listen to other people rather than yourself and be judged by them. Once you have the basic materials you will find watercolour painting a very reasonable hobby to fund.

While going through this book please try and work along with it. Take a section at a time and do a few practise exercises as you read the book. With colour mixing it is easy to do. With perspective and key measure you will need to go out and observe what is written in the book, but you will find this very enjoyable and informative. It is all about observation. I was once out in my caravan at a place called Clumber Park at a caravan site in the middle of Sherwood Forest. I had finished setting up the caravan and was sitting with a glass of beer looking at the trees figuring out how I would paint them when a man came to me and asked if I was all right as I had sat there looking straight ahead for so long. I felt I couldn't tell him I was just looking at the trees, or he would have called for the medics. Always carry a sketchbook with you, a few quick sketches can be very useful in a painting and also good practise.

153 Shuttlewood Rd  
Bolsover  
Chesterfield  
S44 6NX  
Tel. 01246 826311

Web <http://www.watercolourartist.net>  
Email [dave@watercolourartist.net](mailto:dave@watercolourartist.net)

I hope you enjoy this book, David Coupe

As a Watercolour artist and teacher of many years experience I've often thought there was a space in the watercolour market for a book that covers more of the basics of watercolour painting. So in this I am hoping to take you right from selecting your materials to having a good grounding of all aspects of watercolour painting. So



many of the books I have read dive straight in at the deep end and do not give enough credence to the basics. I feel that it is essential that you walk before you run; otherwise everything following is difficult to understand. Also as you go through the book, have your painting materials with you so you can try different things as I explain them. This will also help you to understand what I'm talking about.

I have been painting and teaching for many years and cannot think of a better way of spending my time (maybe a pint and a curry comes close). I started painting when I was about eight and had been sketching before that. I think my mother saw the enjoyment I got from it so bought me a complete set of oils, brushes and canvasses for Christmas. That was the start of it. I would paint well into the early hours of the morning until my mother told me get off to bed because I was at school in the morning. I could sulk all the way to bed.

I wanted to go to art school but in those days it just wasn't the thing for a boy to do and so I joined the NCB as an electrician and stayed there for 10 years until I was qualified and I went on to be an electrical service engineer in many different fields. These included the car industry, the graphic arts industry and Cunard. So I spent a lot of my time in hotel bedrooms wondering what I could do to pass the time. I couldn't take oils into a hotel bedroom so I treated myself to a small set of watercolours and that was it. I was hooked. It has been only recently that I have gone back to oils and I must say I am enjoying them again. The two mediums are so completely different. Oils are so much more forgiving. Make a mistake and you just paint over it. With watercolours although you can lift out most colours by gently scrubbing with a wet brush and dabbing out with a paper towel, you can never get back to the all-important luminosity of the white of the paper.

I never had any formal tuition other than Mr. Gentle my art teacher at school who took me through GCE art. Without his help I probably wouldn't be writing this book. He was my

backup and I hope this book will be yours and that it will be lots of use to you. I have also made a couple of teaching videos on colour mixing and perspective plus a couple of videos where I paint complete pictures. One of Fairford Mill in the Cotswolds and the other Langdale Pike in the Lake District. My videos show every brush stroke. I am sure you, as I do, hate seeing videos where a specific part that you are looking forward to seeing how it is done was completed off camera.

I also do ready to paint sketches that I have sketched on location, scanned into the computer and printed out onto watercolour paper. I have many complete beginners anxious to start painting and I find this is a way they can quickly get paint onto paper and go home with a finished masterpiece.

Because drawing and painting are two totally different disciplines, by using the ready to paint sketches I can leave the sketching part until later. Once a student has become comfortable with the idea of putting paint onto paper and realizes how enjoyable it can be we then start to introduce sketching.

Many people worry about the cost of setting up the materials for painting and I suppose it is a little expensive. But once you have your materials they will last for years and you will be looking at just the price of a sheet of paper. It is important you don't buy student quality paint and paper (you wouldn't expect to win an F1 race on a moped). I cannot emphasize enough the importance of good quality artist materials and after many years of trying most of them I am now happy with what I use. Certainly you will get many years of use from good brushes, and a 5 ml tube of paint will probably last you the best part of a year. It is the same with paper. If you find one that suits you, stick with it. Even if you are practising, you should use the quality paper that you use for your paintings. To practise with one paper and then do your paintings on another makes the practise sessions totally worthless. It would be like practising with a tennis racket when you're going to play cricket.

There are two types of watercolour paper, machine made and handmade. The machine made is wood pulp that is rolled through a press. The handmade paper is cotton and linen that is poured into a mould and the water pressed out. This is a much better paper though more expensive. The machine made paper does not have a watermark and can be painted on both sides. The handmade paper does have a watermark and it is important that you paint on the correct side; you should be able to read the watermark correctly from the side you are to paint on.

Watercolour paper has size either on it or in it. The purpose of the size is just like when you are papering a newly plastered wall, you paint the wall first with the glue and let it dry, this way the wall cannot suck all the water from the paper before it is dry, otherwise the paper is not fully adhered to the wall and will soon fall off. It is the same with watercolour paper, the size is there so when a wash is applied it gives you time to move the wash around before the water is taken up by the paper. There are some papers on the market that have no size on them whatsoever and as soon as you apply paint to the paper the water is immediately sucked out of that wash and you are unable to do anything else with it and so you end up with lots of hard lines showing through the wash which is certainly what you don't want with watercolours.

The handmade papers are made of linen or cotton that is mixed to a pulp, poured into a mould, another frame put on top and the water squeezed out before being removed from the mould and hung up to dry before the size is painted on to the surface. The size of this sheet of paper is now a full imperial sheet. During the making of this paper the manufacturer puts a watermark into the paper and it is important that you are able to read the watermark this then shows you your painting on the correct side of the paper. Handmade papers therefore can only be painted on one side.

Machine made paper is made from wood pulp that while being mixed has the size added to it before being rolled out and cut to size. So this paper is internally sized and you are able to paint on both sides of the paper.

The two papers, handmade or machine made, behave in a totally different way. The machine made is a much harder surface and the brush and paint tend to slide over it. The handmade paper gives a certain amount of drag to the brush and holds the pigment more readily. Consistency is the key.



Before I go any further I must say this. If you are expecting to paint in two or three days don't read any further. I always say you are looking at two years before you get enough confidence and ability to start putting your paintings up for scrutiny. I have had quite a few people come to my studio only to disappear after a few weeks saying it is too difficult. I even had one man book in for one lesson saying he thought he could probably master it in the two hours, he didn't. It is a difficult subject to learn. You would not expect to take driving lessons or piano lessons and succeed



immediately and it is the same with painting. It is so important you don't get disillusioned and give up and it will certainly test your staying power. But if you stick with it I am sure you will reap the benefits and love every second of your venture into watercolour painting.

Also what happens from time to time is what I call 'hitting the wall'. One minute you are painting fine and getting lots of good results then, suddenly you cannot produce a good painting. I don't know why it happens, but it does. What you need to do is continue with it and work your way through (as difficult as that is!) and you will come out the other end asking yourself " what was that all about". But the main thing is, stick with it. So many students when they hit the wall start to talk about giving up and say they are not improving. I tell them to look back on their old paintings only to find they have been used to light the fire. It is important to keep all your paintings as they are always good to look back on, you can then see that there is an improvement.

Another big mistake people make is seeing a particular artist's work and wanting to mimic it. I had one student walk into the studio for the first time and say "I want to paint loose". Looseness can have another word, experience. The more you paint the looser your paintings will become. It is impossible to paint like somebody else. You will see colours in a different way and tones in a different way and even the way you handle the brush will be different so let your own individual style come forward and don't try to copy, as that will hold back your development. My classes include 'paint alongs', where we all work from the same ready to paint sketch. I demonstrate then the students try their hand and work through the painting that way. While I am painting, I will mention something and the student will say you are never told us that. It is impossible; there are so many things to learn it cannot be done in just a few lessons. I have been painting over 50 years and yet I am still learning. This is part of the attraction of watercolour painting. I always say if a thing is too easy it's not worth doing. I learned the hard way. There was nobody to teach me and I learned by making mistakes and then figuring out what I needed to do to correct them. I spent lots of my time looking at paintings in books. Whenever I got a school prize (very few and far between) I would buy a book on paintings and study the paintings intensely and copy them in minute detail. In those days I had two favorite artists, Montague Dawson who painted seascapes and Sir William Russell Flint whose sketches and paintings are just magical. I am not here to tell you how to paint like me, everybody

has their own style (I know this only too well, after trying to paint like Russell Flint and failing). The only thing I can do is teach you the basics that I have learnt over the years and evolved a method that suits me and I hope they suit you as well.

What I am trying to achieve with this book is to take you right from the basics up to a point where you will feel confident with your painting. Please don't skip these basics of watercolour painting as without them you will never achieve paintings that people will enjoy and buy. You will end up with things that are obviously wrong, even to the untrained eye. Nothing stands out more than muddy colours or lines of perspective that go to the wrong vanishing point. It will just stop people wanting to hang your paintings on their walls. There is no bigger thrill than when people buy your paintings for their home and it would be a shame to miss out on it just because of a few hours of practise. Practise is the key word here, even when you have mastered colour mixing, perspective and the key measure you must still continue to practise. You will probably have problems painting trees or skies (everybody does!). So instead of painting a full picture, take time out and with a sheet of good quality paper (it must be the same paper you use for your paintings) and fill it with trees or skies until you are happy with your practise session. Remember, practise makes perfect.

Try not to just read through the book, and absorb all the information in it. Take it one subject at a time. Start with colour mixing and as you read each section do a few practise exercises until you can do it automatically before moving on to perspective and then on to key measure. In the book I have put a few practise exercises for you to try. You can either paint these in the book or redraw them onto some watercolour paper. Either way it would be a good idea for you to do them in conjunction with the book. A useful project in colour mixing is to get a quarter imperial sheet of paper divided into 21 horizontal lines and 21 vertical lines and put every colour you have in your palette along the top and then down the left-hand side.

	cadmium red	cadmium yellow	french ultramarine	burnt sienna	permanent magenta
cadmium red					
cadmium yellow					
french ultramarine					
burnt sienna					
permanent magenta					

Here is a portion of the colour chart before the colours are applied. Your palette will consist of 20 colours and therefore your colour chart will require 21 horizontal squares and 21 vertical. This will leave the squares down the left and along the top for your colours.

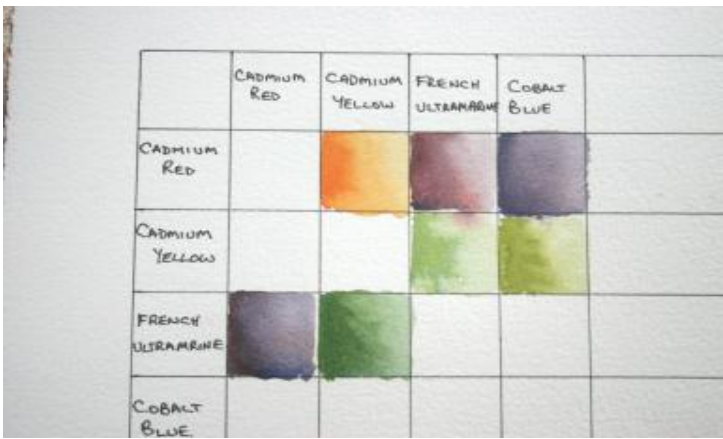

Here I have added a few of the colours and you can see that I started with strong pigment on the left-hand side and lightened it as I went across. This is very useful for showing you the colour across a great range of tones.

You will then be able to mix every colour in your palette together and put it into the square that relates to the vertical and horizontal colours, creating yourself a colour

table that you are able to obtain from your palette. As you apply a mixture to a square, start with a dark tone on the left-hand side and lighten it as you go across the square until you are almost back to white paper on the right-hand side. It is amazing how the colour changes with tone. A typical example is cadmium orange, a lovely warm colour for buildings and rocks when painted very light, but not at all a pleasant colour if overdone. If you are able to, get the sheet laminated so when you go out painting it will not get damaged with mud or rain (yes, be prepared for whatever weather nature can throw at you, it should not stop you painting) and you will be able to compare colours in the landscape to those on your chart to aid your colour mixing. You will also be able to get the approximate colour without the endless mixing of colour, with a bit of this and a bit of that, because doing that gives you only muddy and opaque colours.

It is important you don't try to get the colours too accurate. If you try to mix the green you see in the landscape it will be too powerful for your painting. Green is a very powerful colour and should be used with caution as can be seen if you have ever tried using viridian. The only way it can be used successfully is by mixing reds with it, so there is little point in buying a green when you still have to do some mixing. You will get a better green by making it yourself.

It doesn't matter whether a building is sandstone, limestone or grit stone, use whatever colour you are happy with. In my case I use a very light wash of cadmium orange which strictly is not accurate but gives a wonderful feeling of light and warmth in the painting. If you spend too long thinking about colour mixing your painting will be drying giving you lots of hard lines that will be impossible to get rid of. So the important thing with colour mixing is to make sure the colours are bright and clean. Too many people spend too much time trying for accuracy in their colour mixing. You must get out of the idea that a certain thing has got to be a certain colour it is just not the case. One thing I am not saying is rush your painting. Sadly too many people seem to enjoy the finishing of the painting and not the painting itself which is a shame. I feel they are missing out on so much of the enjoyment of watercolour painting. Take your time and enjoy every brush stroke, good results will soon follow.

By the end of this book you may feel that it is all very mechanical, and in the beginning I suppose it is, drawing a line to this, finding the angle of that, but that's how it will be initially until you get the idea of colour mixing, perspective and key measure. Once you get used to the idea of adding this angle steeper than that and

this line shorter than that, you can then throw away the rulers and angle finders confident in the knowledge your sketches will look more realistic. It is amazing how a line that is not quite the right angle or a measurement that is fractionally short or long or a colour that is slightly muddy can ruin a perfectly good painting. Once you get used to colour mixing, perspective and key measure you will do it automatically, you will look at a scene and because you know what to expect you will sketch it automatically and will not need any mechanical aids. But initially you must use them and it will come easier after time, I promise you all this will not be in vain.

Students who come to me after they have been painting for a while raise an eyebrow when I say I am going to start lessons with colour mixing. People tend to think it's just a case of a blue and a yellow make a green or red and a yellow make an orange, but there's much more to it than that. There are so many different reds, yellows and blues and each one will give a totally different colour. You may require a specific colour but with the primary colours you have selected for your palette it may be impossible to obtain. But don't worry, people will accept it as being correct as they have never seen the actual thing you are painting, and we won't tell them will we! There is one thing I occasionally do when I mix colours together and that is I don't over mix them. I leave them on the palette as a sort of marbled mix, as this way you will get slight variations in the colour as you apply it to the paper. For instance, if you have a large wall you can use this marbling effect to give a feeling that there is texture and life within that wall and it is not just one block of colour.

Different paints have different properties. They may be transparent, opaque, staining and granulating (the pigment settles down into the tooth of the paper and creates spots in the wash). So it is important when you buy your paints to get to know the properties of each colour. If using a staining colour it is most important when you apply the paint not to overdo it straight away as you can always come back to apply a little bit more later. But if it is a staining colour and you apply too much you will never get it back out of the paper. With an opaque colour you will tend to lose the whiteness of the paper shining through. I try to use transparent colours wherever possible but there are cases where you have no option, as with Naples yellow a very subtle warm yellow that is good for clouds. Never leave all white paper for the clouds, as whites can be very cold and are much better if warmed up with a very light wash of Naples yellow. Though a few white areas can be left for the highlights.



As you can see from the colour chart above, there is a whole range of yellows from green yellows to orange yellows. There is a large range of reds from orange reds to violet reds. A range of blues from violet blues to green blues. It is important we add to the palette a green yellow as well as an orange yellow also an orange red and a violet red plus a violet blue and green blue. Any colours that are anything like brown are called earth colours and these are also on our must have list. So you can see picking colours for your palette is very important and dictates the colour balance of your paintings and should be given lots of consideration and once you have chosen your palette you should stay with it. The next time you go to the art shop and see a colour on the shelf which you like don't be tempted to buy it. You don't know the properties of it and it will affect the colour balance of your painting and palette you have taken so long to set up. I cannot stress enough how important it is getting used to your palette so you know where everything is and how to use each colour. I see many people using a white plastic palette and squeezing a little bit of paint here and there. Then when they start painting they have forgotten where they put a particular colour and while they are looking the paper is drying. This then causes hard edges and then they are grabbing sponges to soften that line panic is setting in and things go from bad to worse, just because preparation wasn't done in the first place. So take time out to get things ready first and don't just dive in unprepared. You will never succeed.

There is a thing called mud. This is when mixing turns your colour a muddy grey. Everybody does it when they first start painting but not many people take the time

and trouble to find out what causes it. They just moan that their paintings don't look bright and fresh, which is the essence of watercolour painting given that nice softness that comes from dropping one colour into another. Even people who have painted for a while are amazed how little they know about colour mixing and how easy it is to avoid mixing muddy colours. I often hear students asking why their paintings look so dead and this is because most of the colours used are muddy and not nice and bright. The first thing to do is buy good quality paints. Don't buy the cheapest you can find as student quality paints have more filler in them making them opaque and difficult to pick up from the palette when dried out. Buy paints that are widely available such as those from the main producers so that if you are painting out in the wilds you can still go to the local art supplies for the colour you need. It is so important you use the same materials all the time. When you get used to one manufacturer stick with them as colour differs from one manufacturer to another. I see many paintings and immediately know who has painted them because of the colours selected in their palette. Colour is a very individual thing and it will take you a while to become accustomed to it, so I would recommend you start with my palette and modify it as time goes by.

Pay a few pence more and buy artist quality paints. Many of these are transparent and very strong pigments so in fact you use less paint than with cheaper student quality making them more economical in the long run. Try wherever you can to use transparent colours and this way you will always have the brightness of the paper shining through and therefore have lots of light in your paintings. The brightest thing we have is the white of the paper and if we lose that the paintings can become very dull. I go for a maximum of 20 colours in the palette and avoid carrying grays, blacks, whites and greens (I carry olive green so that when I am doing a painting demo I can pick up a green quickly to save time). Greens are a colour you should mix yourself, as the bought greens are much too bright and artificial. You still need to mix other colours with them to subdue them and make them usable, so what's the point in buying them if you still have to do some mixing. Green is a very powerful colour in its own right and can soon swamp a painting. So save money, leave the greens, greys, blacks and whites out of your palette and mix your own greens. It is easily done and gives better results. Over the years you will modify your palette and put in colours that particularly suit you. Successful colour mixing is all about using as few colours as possible if you can, limit yourself to two lots of pigment in a mix and resist the temptation to go for a bit of this that and the other!







When you first start painting you want to experiment with colours. A raw umber from one manufacturer might have properties you prefer over another. It may be the same colour name from two manufacturers but one may be transparent and the other opaque. Always select the transparent one.

Colour selection is very important but will take you a while to get correct. So to start with, pin the colour wheel on the wall in front of you (there is a tear out colour wheel at the back of the book for you to use) and use it as a quick reference until you are comfortable with mixing colours. One word of advice, don't buy sets of paints as they always include greens, blacks, whites, etc. You are much better selecting your own colours. If you don't particularly like a colour of mine, obtain a colour chart of your chosen manufacturer and pick a colour that is in the range. For example if you don't like permanent magenta you could pick a colour that is close to it, but it must still be a violet red.

Below is a list of colours that I use. The first column is essential and I cannot paint without them. The second column are colours that I like but I only use occasionally (saying that I use a lot of cadmium orange and also cobalt violet). Permanent magenta is also a colour I use lots of. It is a very subtle violet red that can even be used in skies. Many people use alizarin crimson but it isn't as violet as permanent magenta and therefore doesn't make a bright violet and could not possibly be used in the sky of a painting as it would be too bright. It would look like something from a Martian landscape.

**This is my palette....**



Essential colours		
Cadmium red	A bright and warm orange red good for mixing bright oranges.	
Permanent magenta	A subtle violet red. Can even be used in skies as shadows. Good for mixing bright violets.	
Cobalt blue	A green blue, good for skies and good for mixing bright greens	
French ultramarine	A violet blue, good for adding to an earth colour to make strong darks. French ultramarine is the most used paint in the palette.	
Lemon yellow	Lemon yellow is a green yellow and can be used on its own to show a sunlit field. Very powerful and must only be used in small amounts in very light washes.	
Cadmium yellow	An orange yellow which used along with cadmium red will give very bright oranges.	
Raw sienna	The first of the earth colours, more transparent than yellow ochre although a very similar colour. Good for using as a glaze to warm up the picture.	

Burnt sienna	Used with French ultramarine will give a strong dark and can be increased or de-creased to give either a warm dark or a cool dark.	
Burnt umber	Used with French ultramarine will give a nice grey for the clouds.	
Light red	A terracotta colour good for pan tiled roofs and chimney pots. A semi-opaque colour.	
Raw umber	A green brown good for stone roofs if small amounts of green are dropped into it while still wet.	
<b>Non-essential colours</b>		
Cadmium orange	A colour I use lots of. On any type of stone I start out with a very light wash of cadmium orange with light red and cobalt violet dropped into it while wet. A nice colour used very sparingly, but not very pleasant if too strong.	
Cobalt Violet	A nice bright violet that can be used in many instances. Good for flower painters but also used alongside greens in trees and bushes and in little areas of stonework to give texture.	

Olive green	Although I have said mix your own greens, I keep this one in the palette for speed when doing a painting demo, I think it's about the only acceptable green you can buy, much more subtle than many.	
Green Gold	A bright green can be used in small amounts to give the feel of sunlight on grassy areas or trees. It is a powerful colour and therefore should only be used in very light washes.	
Quinacridone Gold	A nice bright gold colour and can be used sparingly in stonework or sand to show sunlight.	
Aureolin	A nice transparent bright yellow towards the orange side, mixed with French ultramarine will give strong green, very useful for such as ivy growing up trees or the shadow in a field.	
Naples yellow	An opaque colour and not a very good mixer but useful for adding a little bit of warmth to the white in the sky being very careful not to allow it to mix with the blue.	

Now we need to look at how to lay out our paints. It is important we know where everything is on our palette. We don't want to be thinking "now where did I put that French ultramarine". It is also wasteful, as paint is often wiped away on the paper towel when cleaning the plate. The plastic plate is useful for mixing colours on, but not for holding your paint. Paint needs to be placed so you know exactly where it is so that it becomes second nature when picking paint

up. The palette can be used when the paint is dry for picking up little bits of strong colour, so don't wash it off and throw away paint. Use a metal palette with good size pans so you can get a large brush into it. Squeeze the tubes into this and leave them to dry. This way you can control the amount of paint you pick up, as you will be using artist quality paint only the smallest amount of pigment gives you lots of strength. With freshly squeezed paint if you put a large brush into it you pick up lots of paint on the brush, far more than you actually need, then you need to clean your brush and end up washing lots of paint down the sink. (I'm near enough the Yorkshire border not to throw anything away!).

If you buy yourself a metal palette one thing you should do initially is to give it a good clean with the cream cleaner. Don't use anything abrasive a few scratches on the surface of the palette will ruin it as paint will get lodged in the scratches therefore polluting subsequent washes causing muddy colours. By cleaning it you remove the mercury from the surface which causes the paint to go into globules, this will improve the more use your palette gets.

When positioning your paintings on the palette, avoid putting complementary colours in pans adjacent to each other. Below I go into what are complementary colours that you will need to read before laying out your palette. Mixing complementary colours is the biggest reason for creating muddy colours and if you were to put complementary colours together in your palette and one spills over to the other it is very difficult and wasteful in paint to get them clean again.

Palettes can vary greatly in price. They start with aluminum which are painted white; there are then steel palettes that are enameled and then brass palettes that are enameled and the price range can go from about £16 to over £300. The aluminum palettes are quite adequate though you must realize, being aluminum, they can soon get dented or bent if sat on, but then don't use the palette as a seat it is only for painting from. Enameled palettes are the best surface, they accept paint better and will last much longer but of course you pay for that in the price. But all in all fold up palettes are much better than using a flat palette to hold your paint, they are much more transportable and will fit in any suitcase ready for your holidays without making a mess of your best shirt or blouse. The inside of the palette is white to enable you to see the tone of the paint, by moving the paint over this surface it simulates the white of the paper and helps in getting the correct tone before applying it to the paper.

There is lots to think about when setting up your equipment, but remember, once you have bought it you will have many years of enjoyment from it so don't go for the cheapest you can find, get one that fits your needs.



My palette, not the cleanest you will ever see!

Now we're starting to think in terms of putting paint onto paper and to do this we need a brush. Don't buy the cheapest brushes you can find but don't go the over top and buy the top of the range Kolinsky sable. Because sable is natural hair it has follicles on each strand and this is what holds the water. The more follicles in the hair the better the brush. There are red sable and Kolinsky sable. Because Kolinsky sable comes from the colder areas it has more follicles on each strand of hair and so carries even more water. That is why Kolinsky sable is the most expensive brush available. All natural hair brushes carry much more water than nylon. With nylon you are forever recharging the brush so it is difficult to lay down a large wash. With all natural hair brushes you must use lots of water to keep the brushes shape. If a natural hair brush starts to run dry the individual bristles of the brush will start to separate and you would need more water to get them back into shape. If they start to dry the brush can be bent and would stay bent. Nylon is just a round filament and therefore has

nothing to hold water, but it does have a nice spring to it. To get the best of both worlds you can buy blended brushes which are a mixture of sable and nylon giving good water carrying capacity with a nice spring to it. Well worth having. There is a whole range of shapes and sizes of brushes, not just round ones as most students tend to buy. A flat brush is extremely useful and in a lot of circumstances much easier to use than a round brush. A large wash brush is very useful and is often made from squirrel hair which is much softer than sable so to keep the hairs together they must be kept very wet at all times. I once sold a squirrel hair wash brush to a lady who complained that the brush didn't work. All the hairs had separated, it looked like a punk hairdo but as soon as she got used to keeping it very wet she was okay with it.

Here we have an example of the type of brushes used.



The first three are flat blended brushes. These are a mixture of red sable and nylon. They have lots of use in watercolour painting, but sadly neglected by most beginners of watercolour painting.

The next brush (fourth from the left) is a nylon filbert that is made very thin and the bristles separate, good for doing grasses.

The next is a Kolinsky sable filbert. A good brush for washes because it is sable that holds lots of water.

The squirrel hair wash brush, (six from the left) again carries lots of water and good for the bigger washes.

Another type of brush is the squirrel hair which comes to much more of a point so good for small washes with detail. Because it is squirrel hair it needs lots of water to keep its shape.

A round Kolinsky sable brush (eight from the left). A good all-round brush with the quality of Kolinsky sable. This is the brush that most students tend to buy but don't just think you have to use the point. Explore new territory and use the side of the brush, it can give very interesting texture and effects that cannot possibly be painted.

The last two brushes are types of rigger. The first is a reservoir brush; it has a sable point surrounded by squirrel hair. The squirrel hair increases the water holding capacity of the brush, one to be tried.

Last of all the more traditional rigger. A good Kolinsky sable brush with lots of uses not just the painting the rigging of ships or by using the side of the brush lots of interesting shapes can be achieved.

The rigger got its name when artists used it to paint the rigging on ships. It has a long sharp point and is a wonderful brush for painting the twigs and branches in trees. When painting with a rigger it is important your hand leads the brush so the paper will keep the bristles of the brush in line. If the brush leads your hand the bristles then have a tendency to separate and cause a broken line. The rigger is also a good brush to scumble with. To scumble the brush on the paper is to scrub the brush onto the surface of the textured paper to give a broken effect, a good technique for giving texture to surfaces. Don't always think you need to use the point of the brush. Using the side gives some wonderful effects that cannot be achieved with the point. Again, it is a thing that needs to be practised to see what effect you can get from each brush. Never used cheap paper to practise on, always use the same paper whether you are practising or painting a masterpiece.

## COLOUR MIXING

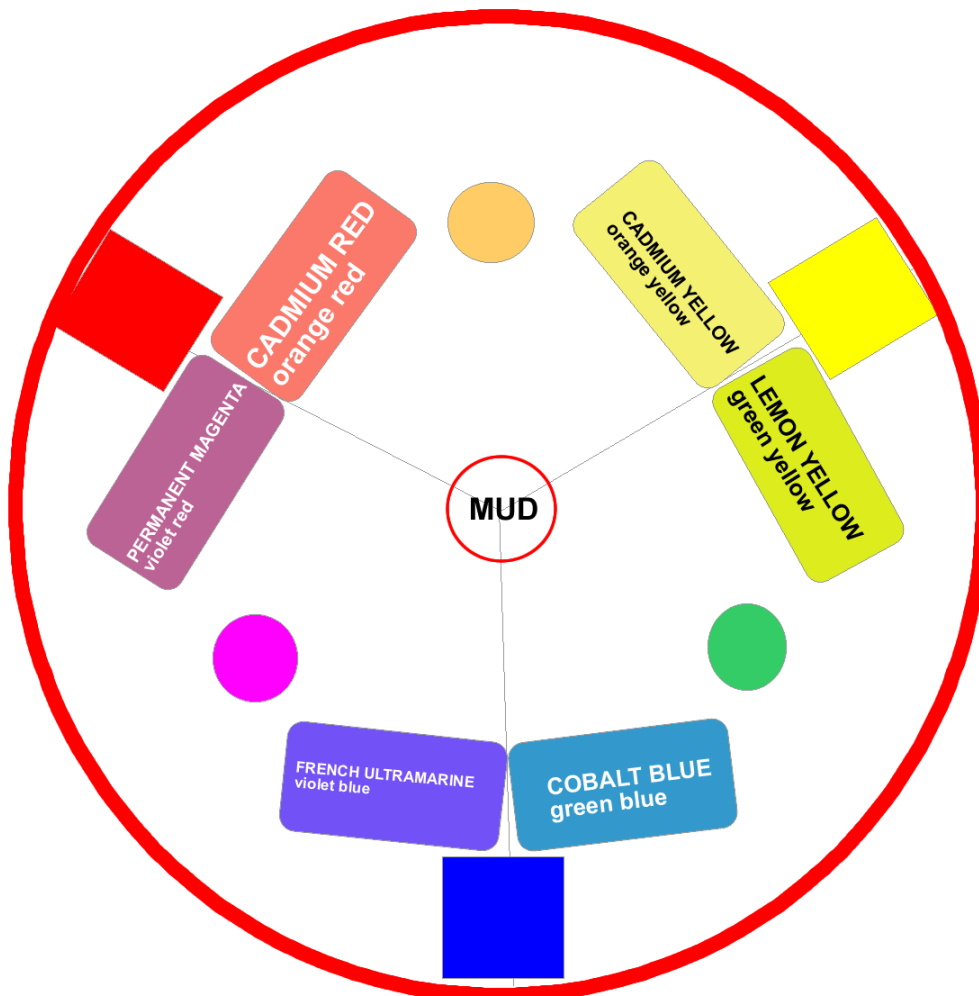

If we now look at the colour wheel, the squares represent primary colours, red, yellow and blue. If we mix any two primaries together we get the secondaries and they are violet, orange and green. When mixing colours try to stay away from the centre of the circle, the area of mud. It is a good idea to copy the colour wheel and pin it up in front of you when you are painting so a quick glance will show what to mix and what to avoid. As with everything the more you use the colour wheel, colour mixing will become second nature.





If you obtain a Winsor and Newton colour chart you will see all the colours laid out starting with lemon yellow going through the standard yellow to cadmium yellow, through the oranges to cadmium red, through the standard red into permanent magenta, through the violets to french ultramarine, through the standard blues to cobalt blue through the greens and back to the lemon yellow. If we look at it in terms of colour balance, we go from the green yellow through the yellows into the orange yellows through the oranges into the orange reds through the standard reds into the violet reds through the violets into the violet blues through the standard blue through the green blue through the greens and back to the green yellow. One colour I do like is permanent magenta, but you may not but if you need a violet red you could use the violet red near to it such as cobalt violet or quinacradone magenta. By doing this you will arrange the palette to suit your taste and this is what will give your painting's your character.

The square boxes are the primary colours red yellow and blue. As you can see from their colour chart above there is no such thing as a standard red standard

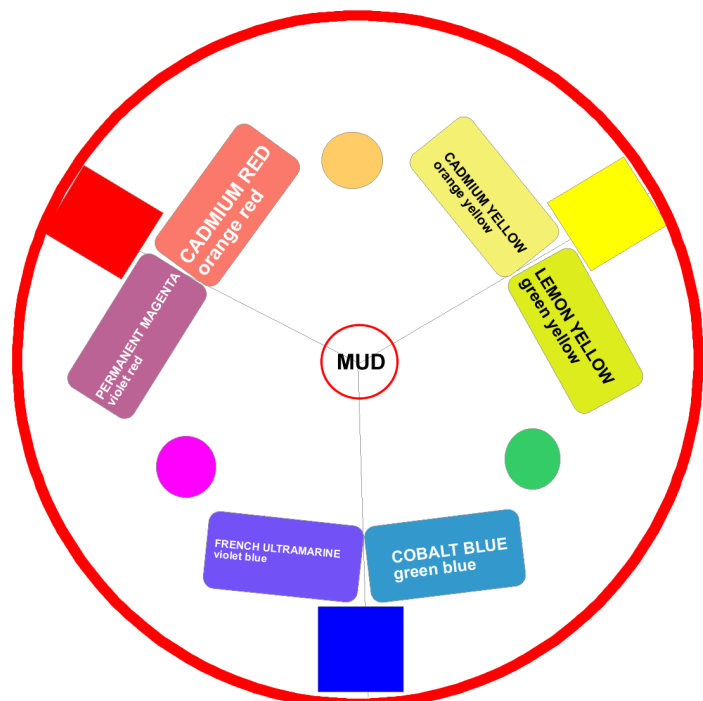

yellow or standard blue. What I have done is to select a red in the centre of range and the same with the yellow and blue and called it a standard red yellow or blue.

Applying the above let us fit it into our circle. So let us start with the green/yellow (lemon yellow) through a standard yellow, through the orange/yellow (cadmium yellow) through the orange on to orange/ red (cadmium red) then a standard red into the violet/reds (permanent magenta) through the violet into the violet /blues (french ultramarine) through the standard blue into the green/blue (cobalt blue) through the green and back to the green/yellow (lemon yellow).

The important thing in avoiding mud is coming to grips with the concept that complementary colours (colours that are at the opposite side of the wheel) give mud when mixed together. It can also be looked at in another way in that it is dulling that colour. So it doesn't have to end

up as mud, it can be a bright colour just dulled down. This is a very important part of colour mixing, it is not just a case that we have to be happy with either a bright colour or muddy colour, we can get something in between. It may be that we want a green that is not too bright and not too muddy. To get this we take a bright green and just add a small amount of its complementary, in this case red. What this does is take away that brightness and acidity of

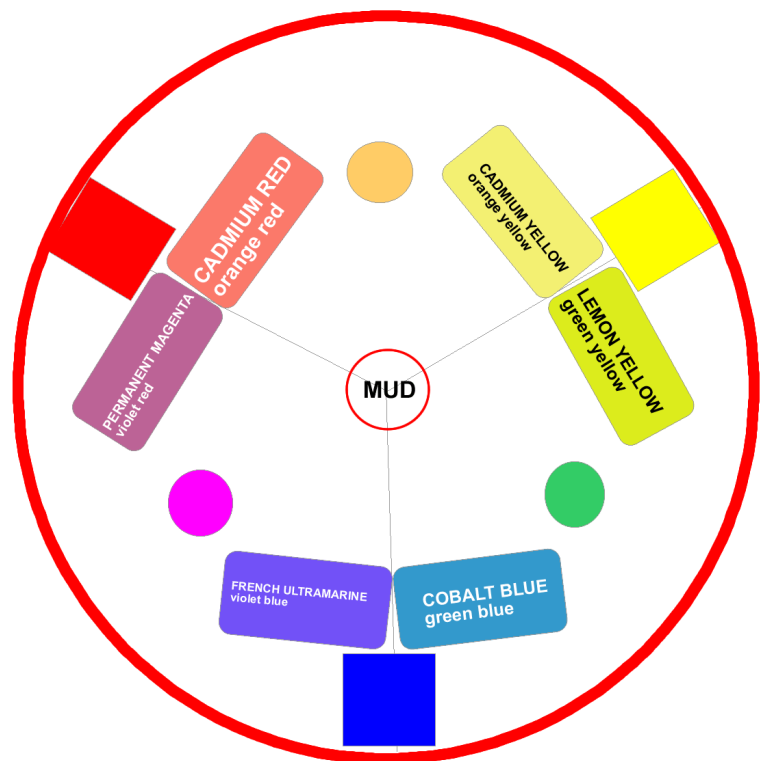

the green and gives it slight warmth. So when I talk about greying colour, it doesn't have to be mud it can be a toned down bright colour. It is important when mixing a colour that you can visualize the colour you require in your head, and not just guess the one you are trying to achieve and how to obtain that colour.

So now, let us expand on our colour wheel and add to our standard colours the standard colours with colour bias added. For example the violet red (a standard red with violet added) is permanent magenta and the orange red (the standard red with orange added) is cadmium red, the orange yellow (yellow with orange added) is cadmium yellow and the green yellow (yellow with green added) is lemon yellow and a violet blue is french ultramarine (blue with violet added) and green blue (blue with green added) is cobalt blue.

Draw a line anywhere through the centre of the colour wheel and we get the complementary colours. Yellow is the complementary of violet, red the complementary of green, french ultramarine the complementary of cadmium yellow etc. It is the mixing of complementary colours that causes mud, as one cancels out the other. The centre of the circle where all the colours intersect is the area of mud. So we can easily be seen that if we mix all three primary colours together, red yellow and blue, we get mud. Many students engrossed in getting the correct colour will pick up any colour in the hope they will get it right and all they are doing is mixing muddy colour because no thought has being given to mixing complementary colours.

So if we have a bright violet on our palette and we want to take away that brightness (this is to muddy it a little) we would add its complementary which is yellow and that would move it slightly to the centre of the wheel (the area of mud). More can be added to achieve the right degree of brightness. It still may be a little bright but this time by adding a little bit of the yellow we could end up in the area of mud, not pleasant! But this can be remedied by adding a little more of the violet, which would take it back to the violet side or more yellow which would take it to the yellow side of grey. So not all is lost if you do mix a grey.

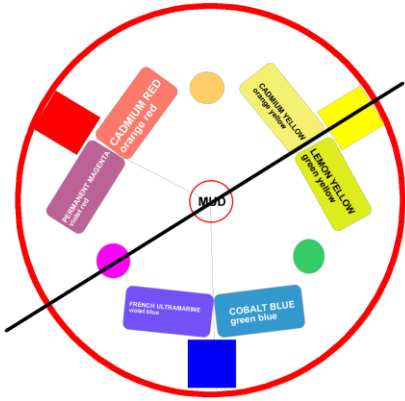

We now look at the complementary and in this case by drawing a line from violet through the centre of the wheel we come to yellow and so yellow and violet are complementaries.

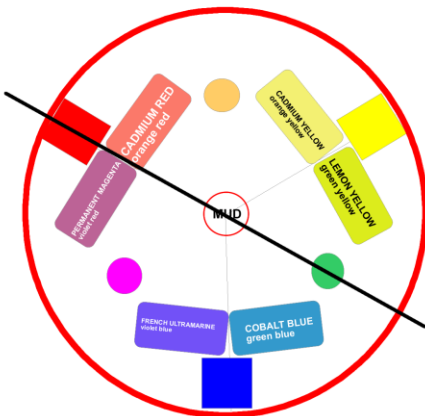

Now by drawing a line from the green through the centre of the wheel we come to red and therefore red and green are complementaries

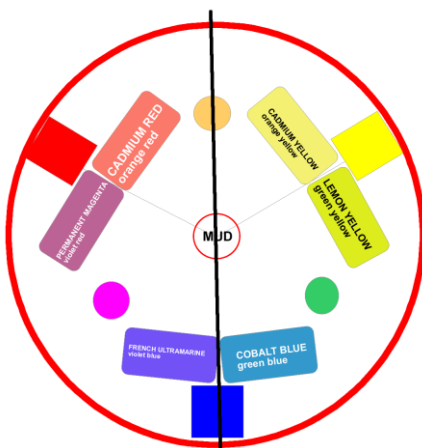

If we draw a line from blue through the centre of the wheel we come to orange which is the complementary.

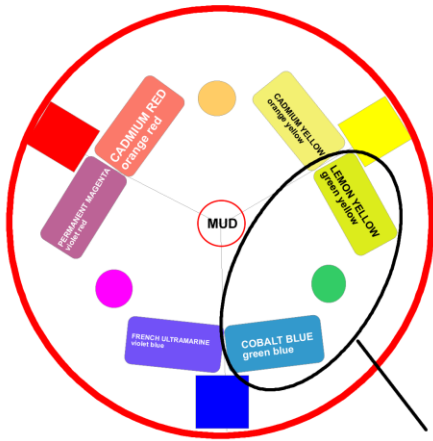

To mix a bright green we want to colours that have got green in them they are cobalt blue and lemon yellow. The green that is already in these colours assists us to make a bright green.



For a bright orange, we must use the red and yellow that have got orange in them which are cadmium red and cadmium orange. These two colours give us a bright orange.

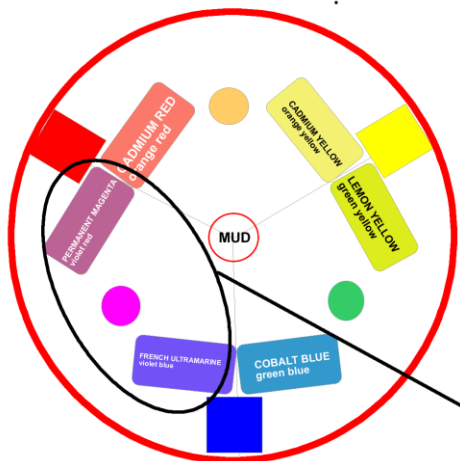

To make a bright violet again we look at the two colours that have got violet in them and they are french ultramarine and permanent

magenta. The violet in the permanent magenta and french ultramarine enables us to make a bright violet.

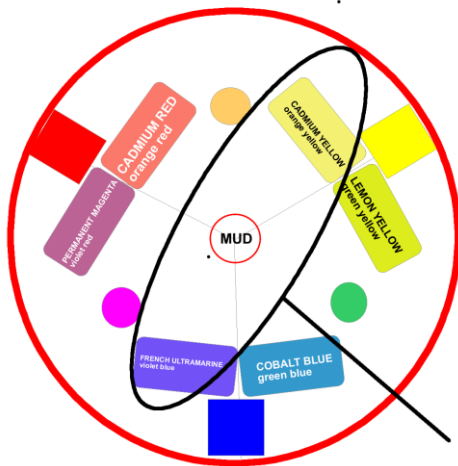

To make a muddy green we need colours that have got the complementaries in them, which are french ultramarine with violet in it and cadmium yellow with orange in it. These are going round to the complementary side of green and so they give us a muddy green when mixed together. This is not always a bad thing if you want the ivy growing up a tree or the shadow in a grassy field. You need the strength of a muddy colour for this but not if you want the green to look as though it's catching the sun.

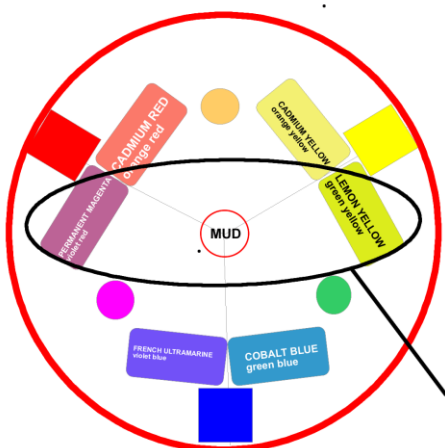

Now we want a muddy orange so we look for the colours that have got the complementaries in them which are permanent magenta that has violet in it and lemon yellow which has got green in it. Mixing these two together gives us a muddy orange.

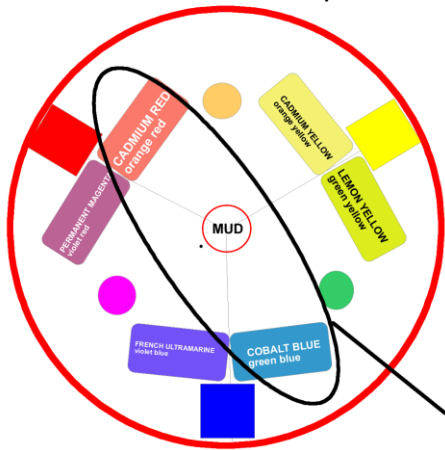

And now for a muddy violet. Cadmium red has got orange in it and cobalt blue has got green in it so mixing these two together gives us a muddy violet.

Working with complementaries is not just a case of primaries working with secondaries, it can also work with any colour on the wheel. For example French ultramarine and cadmium yellow are complementary as are lemon yellow and permanent magenta. So anything directly opposite are complementaries and that is why if you were mixing a green and used French ultramarine and cadmium yellow (when all said and done a blue and a yellow which should make green) it turns out to be a very muddy green.

We can see mud can be mixed on the paper as well as on the palette. Normally it comes from using complementary colours one on top of the other and fiddling when laying down colour. For a start you must get out of the habit of brushing the paint on as though you're painting a door. With watercolours the water will smooth out the wash unlike oil paint which needs more brush action. If you have an area of a painting you feel is too green, you can lay on a wash of red to subdue the green. All will be fine if you use a big brush and put down the red in one brush stroke so as not to disturb the under wash, therefore remaining bright. If you use a small brush to put down the red wash, it will tempt you to use more of the brushing action, therefore lifting the under wash causing mud.



Here we have an example of mixing mud. We have a bright yellow and a bright violet (complimentary colours) and the resulting mud.

So when painting in watercolour it is important to remember that the pigment placed on the surface of the paper can be easily disturbed unless it is a staining colour that has soaked into the paper. The fact that we can lift paint off paper is both an advantage and a disadvantage. If we make a mistake we can scrub the paint with a wet brush and lift off with paper towel. It is a bad thing if it soaks into the paper and cannot be removed or modified. In that same scrubbing action we can lift and mix the pigment. So when you are glazing (putting one layer of colour on top of another) one brush stroke and all will be well, but two or more and you have problems.

To make a bright green we use a yellow and blue that have got green in them and that is lemon yellow and cobalt blue, giving a very bright spring green (top left). If this is too bright we can dull this down by adding just a little of its complementary red (top right). If the green is to the yellow side then the complementary is permanent magenta, if it is to the blue side then the complementary is cadmium red.

We can also make a dull green by using the blue and yellow that has got a little bit of the complementary of green in them (bottom left). So now we use french ultramarine that has got violet in it, and cadmium yellow that has got orange in it, because

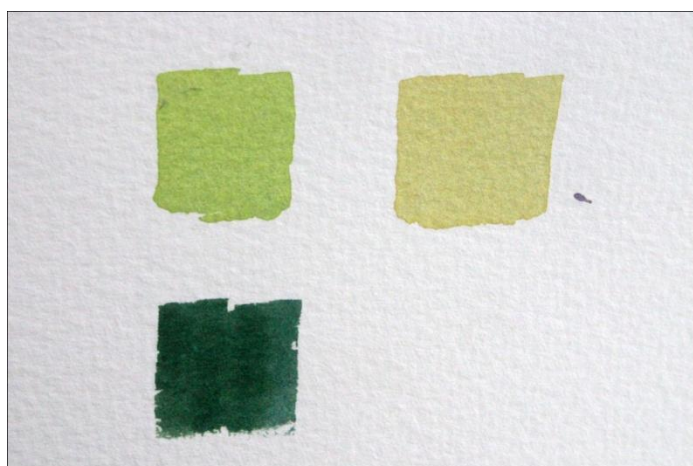



the orange is going round to the complementary side of green as is the violet. From the colour wheel we can see French ultramarine and cadmium red are complementary colours (opposite on the wheel) and therefore it can be expected to mix a muddy colour.

If we want to mix a bright violet we would look for the blue and red with violet in them, which is french ultramarine and permanent magenta (top left) If this violet is too bright just add a little yellow its complementary (top right). If we want to mix a violet using the colours that have the complementary in

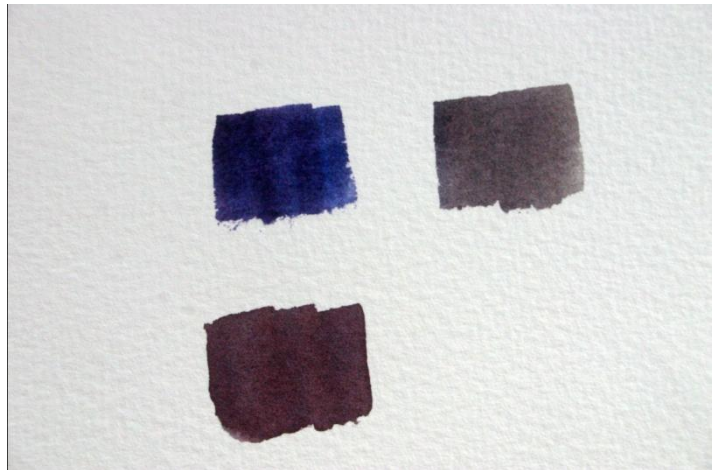

them we would now use cadmium red and cobalt blue (bottom left). Cadmium red having orange in it is heading towards the complementary side of violet and cobalt blue which has green in it is heading to the complementary side of violet giving us a muddy violet. But this is a colour that can be used for a slate roof on a building, for if you look carefully at a slate roof you see that muddy violet colour. Again cobalt blue and cadmium red are opposite on the colour wheel and so a muddy colour can be expected.

For a bright orange we need the two colours with orange in them, so that is cadmium red and cadmium yellow (top left). If we wanted to dull this down a little we would add a little of its complementary which is blue (top



right). For a dull orange using the colours that already have the complementary in

them we would use permanent magenta and lemon yellow (bottom left). So you can see it is not difficult to avoid mixing muddy colours but if you want a muddy colour you know now how to mix it as there are times it can be very useful.

As I said I don't carry blacks, greys or whites in my palette, preferring to mix my own dark colours. Do not use too much water; you will only obtain a nice crisp dark colour by using just enough water to pick the paint from the palette and no more. This is where the plastic plate that you have been using for mixing colours comes to the fore. There is always a dry colour somewhere on the plate that is about the right colour, and as long as you don't use too much water on the brush the colour you pick up from the plate will give you a nice dark. For a dark colour I always use french ultramarine and then any of the earth colours such as burnt sienna, burnt umber or light red. It's a good idea to mix an assortment of dark colours and look at the colour difference you get with each. You can then apply the different greys for different circumstances. The dark colour can then be mixed to the cool side or the warm side (using more of the blue or brown), so in a warm picture you would use more of the earth colour to make it warmer and more of the french ultramarine will make it cooler. This makes the darks in keeping with the feel of the painting. Also the dark it will make will be much more vibrant than the bought greys or blacks making your paintings much brighter and more interesting.

Always use good quality paper to paint on. There are basically two types of paper, machine made and handmade. The machine made is normally wood pulp that is rolled through a press and then cut to size. Handmade papers are normally made from cotton and linen which are put into a mould and then pressed to remove the water. The machine made papers have size put into them when the pulp is being made whereas the handmade papers have size applied when removed from the mould.

I use Saunders Waterford which is a handmade paper. It is a little more expensive but you will find the results you obtain more than compensate for the small extra cost. This paper grabs the pigment of the paint and is therefore a big help in controlling the flow of the paint. Some papers have a hard surface and the paint will slide uncontrollably. Another factor is the size on the paper. For example if you want to paper a freshly plastered wall you paint it first with the adhesive you will be using

on the paper (this is sizing the wall ) and this stops a lot of the water being sucked from the paper and so makes the paper stick better to the wall. With watercolour paper the size stops the water being absorbed into the pulp of the paper. Some papers that are classed as being water colour paper do not have a good size on them and it is almost like painting on cartridge paper. Again it is all about paying a few pence more for artist quality materials. I must admit, when I first started painting, I thought paper was paper what difference can it make, but I was so wrong. Try different types of paper as what suits one person doesn't suit another. It's not until you have tried other papers you will see what the differences are and make your own decision as to which suits you best.

If we now look again at the colour wheel and consider which is the warmest colour on the wheel we could say cadmium red. If we were to rotate in an anticlockwise direction we would go through the violets, therefore getting cooler, through the blues, getting cooler, through the greens, getting warmer, through the yellows getting warmer and back to cadmium red. Therefore we are swinging from cadmium red through the cool colours and back to cadmium red. If we were to swing in a clockwise direction we would be going from the cadmium red through the yellows getting cooler through the greens cooler through the blues getting warmer through the violets warmer and back to cadmium red. Therefore no matter which way we go cadmium red is always warmer than permanent magenta, french ultramarine is always warmer than cobalt blue and cadmium yellow is always warmer than lemon yellow. We can make use of this with aerial perspective, which is where cool colours go away from us, and warmer colours come forward. For example, if we had two cornfields in a picture what colour would we paint the cornfields? Of course we would paint them yellow, but which yellow, if we paint both fields cadmium yellow you can see that all we get is a yellow vertical shape.

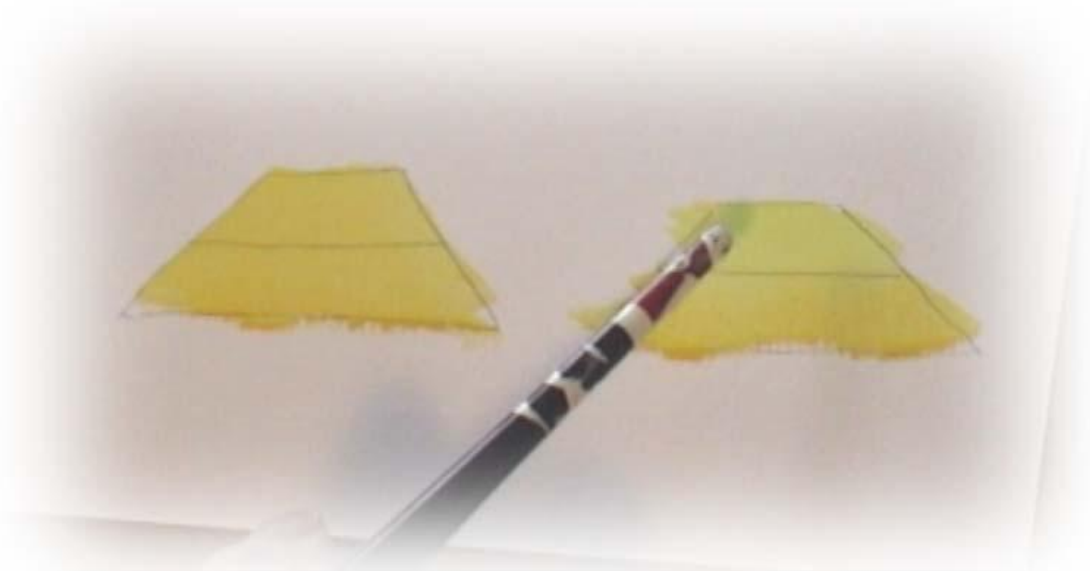

Now if we paint the nearer field cadmium yellow and the further field lemon yellow (the painting on the right), because lemon yellow is cooler than cadmium yellow it goes away from us and therefore the fields are now laid down and give us a good feeling of distance, the lemon yellow in the distance compared to the warmer cadmium yellow. The same with the sky. If we put french ultramarine at the top of our painting and as we come down the paper start adding cobalt or cerulean (both cool blues) towards the horizon, this will then put the sky into perspective the warmer ultramarine coming forward and the cooler cobalt going away from us. If it was all one colour the sky would be sitting vertically in the picture. If we had two telephone boxes in the picture using cadmium red on the nearer one and permanent magenta for the distant one this again will give us perspective, the cadmium red would come forward and permanent magenta would go away. Using warm and cool colours this way is called aerial perspective. If you look at distant mountains you will see a cool blue grey and for this I use french ultramarine and burnt umber but make it to the blue side, which I call my blue grey. It will require lots of french ultramarine and just a small amount of burnt umber, just enough to take away the blueness and dull it. I make lots of this colour at the start of the painting as it can be used to glaze over a warm section to indicate shadow areas. But be aware, it is very easy to make this colour muddy! So you can see it is important we have a warm and cool of each primary colour.

## tone control

Now you have learnt to mix colours it is important to learn how to adjust the tone of the colour. Tone is controlled with the use of water which is why we use a brush that holds lots of water. This is very important so throw away those nylon brushes, though one can be saved and used to pick up paint from the palette thus saving a good-quality brush from misuse. To control the amount of water on the brush we use absorbent paper towels. If we wash the brush we must then always touch the brush on the paper towel, never going straight from water to palette or paper. Don't squeeze the brush on the paper towel or you will remove too much water, all you are trying to do is to get rid of the excess water in the brush. Always have paper towel available as controlling the water on the brush is an essential part of tone control. Whenever I am painting I always have paper towel in my left hand. Not only is it useful for tone control it is always useful if something goes wrong with your painting for wiping away the tears! Even going straight from the water into a pan of paint will leave lots of water in that pan making it impossible to pick up a strong colour.

Here again the cheap white plastic plate or tray, being a flat surface it will stop you making mixes with lots of water. You need to control the tone of the paint with the water on the brush and not water on the palette. If a very large light wash is needed then you will need something like a daisy palette that will hold lots of wet wash. A good thick mix on your tray and very little water on your brush will give you a very dark tone. A lot of water on your brush and a small amount of the same pigment from the tray will give you a light tone. Therefore from one mix you can get a great range of tones instead of a wet wash giving you only one light tone. Then you start adding lots more paint that can be very wasteful the more water in the palette the more wasteful it will become. So that is why a good-quality sable brush is essential, using the brush to control the tone we are applying. Without the water-carrying capacity of sable brush we would have to rely more on wet washes on the palette and this we don't want to do. Controlling the water is one of the most difficult things in watercolour painting. But the water is there to help you, not only to put beautiful washes on your paper but also to control the tone which is probably the most important part of painting. We must try to achieve a good range of tones. To the student this is a very difficult concept as they are so busy concentrating on colour (as

I have said before that doesn't matter) they forget the more important part which is tone control.

Put some paint on the paper then load your brush with clean water move that paint around Look what happens to the paint. Where there is more water than paint you see the white paper shining through and the colour glows. This is because the paint is transparent and you now see the white of the paper shining through.



This vibrancy is the beauty of watercolours. If we look at the picture below we can see a tonal scale which runs from zero (white paper) to 100 (pure strong pigment). We try to achieve every one of these tones in a painting but the majority of the painting will be done between 20 and 80% however we still need 0 and 10% as we do the 90 and 100%. If we do not get this good range of tones the paintings will look flat. It is amazing how just a little bit of contrast in tones i.e. zero and 100% in your paintings will improve them enormously.

This is one of my tonal sketches done out of doors. In this I have decided where to put my lights and next to

them the darks. In the picture this gives a good range of tones with no single lines to separate individual items. This type of the sketch will help you enormously with your painting by giving you a good idea of putting lights against the darks.

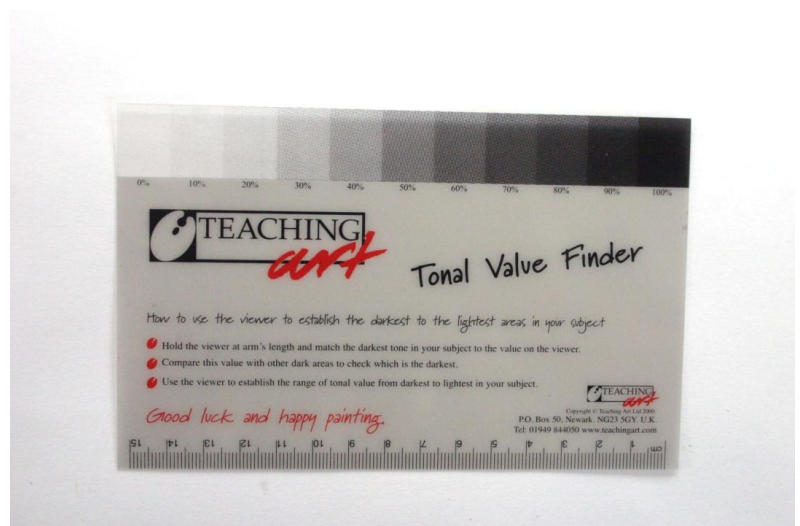

It is a good idea to practise doing a tonal scale with pencil or paint. Doing this gets you used to controlling the weight on the pencil or the amount of pigment in the paint. After a while you will find you will be able to look at a tone and repeat it on your sketch. As I said earlier, tone is the most important thing in watercolour painting and if you can get used to working with it success is bound to come in your painting. To enable me to get good sharp darks I like to use a mechanical pencil (they used to be called a propelling pencil) and I advise anybody starting out to use one instead of ordinary pencils. I have never seen anybody keep a sharp point on a pencil and with a mechanical pencil the point is always sharp. I use .5 mm 2b leads when doing a tonal sketch, and .7 mm 2b leads when I'm sketching on watercolour paper. I use the .7 mm 2b lead on watercolour paper so that I don't scratch the surface of the paper which can damage the size and cause the paint to soak into the pulp. Don't hold the pencil down near the point, hold it up as far as you can from the point so that you have more control over the weight exerted on the point. This will also it will release pressure from your hand so that after a day's sketching you will not have writer's cramp. It is also much easier to control the shading in your picture holding your pencil this way. I advise you not to do too much rubbing out when sketching. If you do need to rub out make sure you use a putty rubber to avoid damaging the surface of the paper. A putty rubber can be shaped to a point to remove tiny bits of pencil to lighten up an area.

To really see the benefit of tone control, find a nice scene out of doors and just using your pencil try to capture that scene. This then becomes your tonal sketch. It is so important that you try to work out of doors and not just from photographs. A photograph cannot capture the full tonal range the human eye can see and what you end up with in the photograph are large black areas due to under exposure. If you were sitting there you would see shapes within those dark areas instead of just a large black area. I can always tell when somebody has painted from a photograph as they try to capture those blacked out areas instead of putting a little detail in there that the eye would normally see.

Without tone your paintings will be flat without life or depth (so many of the students say to me why do my paintings look flat and they have just answered their own question). If you struggle with tone you need to do a number of monochromes. When you do a pencil sketch you are doing a monochrome as you only have the tone of the lead to work with. You can also do it with paint but you really need a very strong pigment such as burnt umber or French ultramarine. Monochromes are quite enjoyable to do and you can achieve some good effects. You can also work with tone sitting in the comfort of your armchair by the fire. Just look at your coffee cup, at the lights and darks in the cup and around the lip of the cup. Try a pencil sketch of that cup and you will be surprised what having a good range of tones will do for that sketch. I cannot emphasize enough how important tone is. Just go around a few of your local art exhibitions and look at some of the paintings and you will see what I mean. The paintings with a good range of tones always look much brighter and lively. I find sketching very enjoyable and after a while you will find that most sketches will only take you about an hour. The sketches in their own right can look good framed because of the depth that can be obtained with just pencil. You can use a fairly soft pencil, a 6B for example and with this you will be able to get a good range of tones including very strong blacks.

In this study of the horse by Leonardo da Vinci look at the range of tones he has employed and because of this the sketch has impact and depth. It has also a good range of tones that help in the creating of muscle shape. Have a go at copying this sketch, you will be amazed what can be achieved with pencil.

Don't be afraid to use the side of the pencil to cover large areas. It will give a much softer shape than the hard point. If you go out for a day's sketching it is quite easy to get five sketches off in the day. These taken back to the studio will give you lots of material to work from where as in a day's painting you may only get one





painting done and what do you do with it? You frame it and put it on the wall, so sketching is more productive than painting when out of doors. On my painting holidays I try to push the sketching side. After all, five days sketching could yield 25 sketches to work from and this can carry you through the winter. Again, practise makes perfect, sketching being as much an art as painting. I love to go through the sketches of Leonardo da Vinci, and study his work. I really encourage you to do the same.

One quick note here, if while sketching, the light changes or the sun comes out and lights the subject just as you would like then this is the time to take a photograph. You are not going to be using the photograph to paint from, that will be done from your sketch, but it is for the effects of lighting and shadows etc. I have seen it many times when painting Langdale Pike in the Lake District, that those deep powerful clouds have opened for a split-second allowing a shaft of light through to strike the mountains. Capture this on camera as you would not have time to sketch it and it is a moment not to be missed.

## PERSPECTIVE

Now let's have a look at perspective. It is a subject that scares many and yet there are just a few basic principles so perspective should not be a problem.

Make yourself an angle finder from two plant labels joined by a paperclip. With this you can capture any angle that you can then place down onto your paper. Let's start by going out into the garden and walking around the house looking at angles with your angle finder. Put one leg of the angle finder on to a vertical which could be a window frame, the corner of the house or a post, anything that you know is vertical. The other leg of the angle finder can now be adjusted to a gutter line the top of the window or the top of the door. Move around the garden taking the same measurement and see how it differs.

If we were square on to a wall and we took the angle between the side of the house and the top of the window we would see it gives us a right angle. Now if we move to the

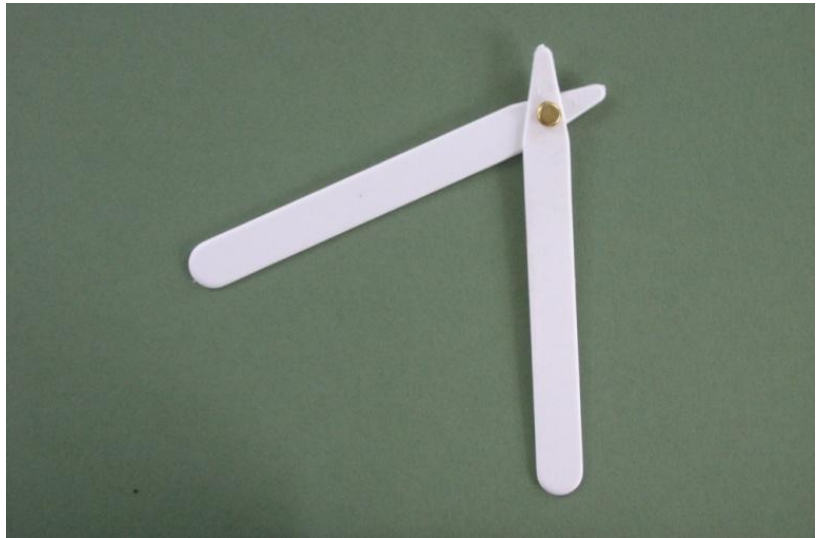

side of the house and measure the same angle we can see how that angle has changed. We can now move to the other side of the house and measure that same angle and you can see it goes the other way. So we can now move right up close to the wall so that we can only just see the window and take that angle again. We will see that it is now a very acute angle. I can guarantee you will be amazed how steep such angles will be and you will think to yourself it just cannot be that steep. This is your brain overruling your eyes. Paint what you see and put that acute angle down it will look fine.

Take the shapes below. The one on the left is going away from you left- to- right, the one in the centre is square on and the shape on the right is going away right-to-left. This may sound basic but it is very important in perspective that you look at the

building and see which way it's going relative to you which affects the angle you see of the building.

Now again go out into the garden and look at the gutter line first from the left-hand side of the house and then from the right using your angle finder to capture these angles and direction. Now take a sheet of sketching paper and practise just doing the basic outline of the house first from the left and then from the right, at this point don't bother about windows or doors as it is just a basic outline we require. Now look at your sketches, and see which way that wall is running whether away from you left-to-right or away from you right-to-left as in the sketches below.

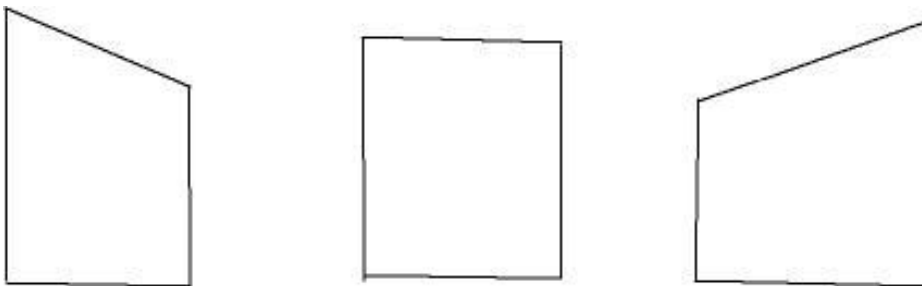

The first thing you need to do is get your eye line. There are gadgets on the market for doing this but they are expensive when all you need to do is put your arm straight out with your fingers level with your eyes and whatever you are pointing at is on your eye line.

When you are finding your eye line just make sure you are not pointing in the direction of some huge man mountain, it could be dangerous this is one of the first 'don't do it's' of watercolour painting!

Once you start your painting remain in that position. You cannot start the painting seated



then halfway through decide to stand up and sketch as by doing that your eye line has moved up the picture by however tall you are. Even if you decide to go for a coffee mark the position of the legs of your chair so that on returning you can position your chair exactly as it was. Once you've got your eye line, use a picture finder to obtain the picture you want and look where your eye line is in the picture finder. Your eye line may be a quarter of the way up, a third of the way up or three-quarters of the way up. You are then able to put a cross on the edge of your paper or on the drawing board showing the position of the eye line in your painting (step one). The importance of the picture finder is not just for organizing your scene; it also positions your eye line on the paper to give the effect of looking up or down.

Here we see the picture finder. You move it away from or closer to your eyes to capture the scene you want to paint. You can also see the crosshairs to help you position your focal point.



So once we have decided on our eye line in the picture we can now consider the building. If you lay on the ground with your eyes level with the ground then the ground would be our eye line as in step one below. Any buildings in the picture would rest on the eyeline as in step two.

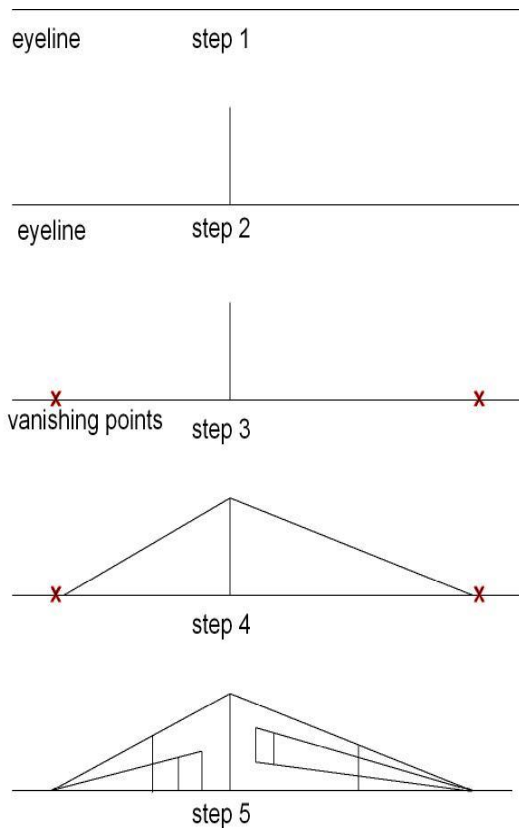

Step 1. The eye line is drawn in.

Step 2. The front corner of the building is drawn in.

Step 3. The vanishing points are positioned.

Step 4. Lines are drawn from the top of the building down to the vanishing points.

Step 5. The other corners of the buildings doors and windows are now drawn in going to the appropriate vanishing points.

The nearest corner of the building can now be drawn in (as in step two). We can now put in the vanishing points on the eye line (step three) for more information on positioning the vanishing points please go to the next paragraph. We can now draw our lines from the top of the building down to the vanishing points (step four). We now finish by putting the other two corners of the building including any windows and doors that must also go to the appropriate vanishing point and the building is now complete (step five).

To fix the vanishing points on the eye line I devised an angle finder that we used earlier when looking at what happened to angles when moving around the house, shown below. With this you can put one leg of the angle finder on any vertical and adjust the other leg to the angle required. This angle can then be transferred to your



paper and then, by extending this line down to the eye line this gives you the vanishing points.

If we stand up as in the diagram below, our eyes go up the building by however tall we are and our eye line is now not the bottom of the building. As before, we now find the vanishing points and extend the line from the top of the building down to the vanishing points and from the bottom of the building up to the vanishing points. We can now finish off the basic building, and put in the doors and windows. If the top of the window is above the eye line then it must slope down to the vanishing point of the wall and if it is below the eye line it must go up to the vanishing point. It is the same if we put a door in the picture. The bottom of the door will go up to the vanishing point of the relevant wall and the top of the door will go to the same vanishing point.

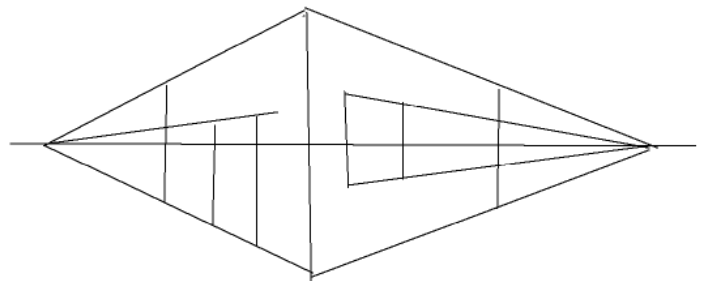
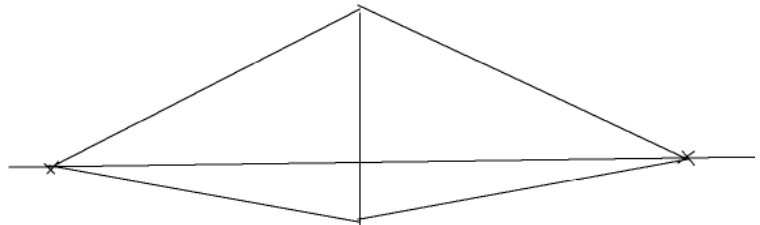

If we are going to paint a scene which has a wall in it we can make use of the wall to give us our eye line. We know that any mortar lines above the eye line will go down to the vanishing point and any below the eye line will go up. So, all we need to do is look for a horizontal course of mortar and this will give us our eye line quickly and easily, as in the diagram below.

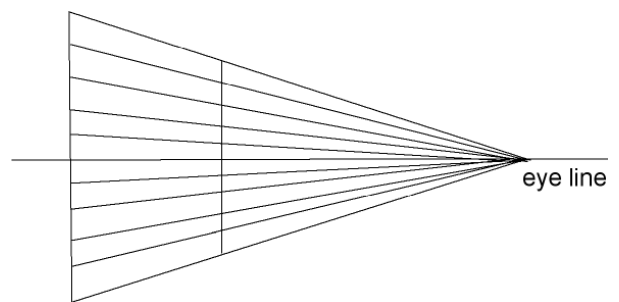

Below you will see a sketch of a wall as you would see it in real life. Look at it and try and decide where your eye line is purely by looking at the mortar lines. If you then draw a line through what you think is your eye line and then take any two of the mortar lines and see if they cross this then gives you the vanishing point for the wall and because the vanishing point has to be on the eye line it also gives you the eye line. You can then check the other mortar lines by extending them down to the eye line and see if they join up with the vanishing point. If your original estimate for the eye line is correct all these mortar lines should join at one point.

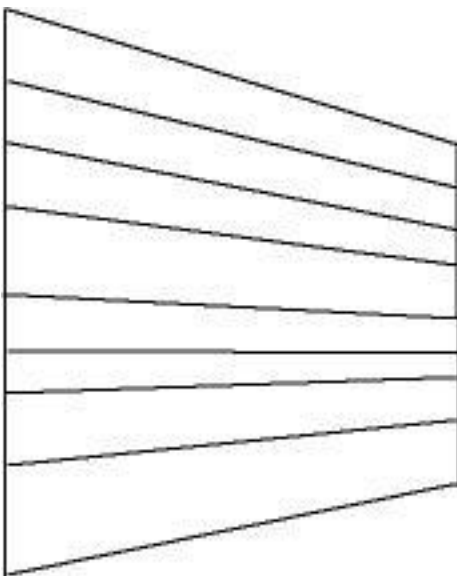

Any man-made horizontal that is on the eye line will be horizontal. If you are out of doors painting and you see the door or window is horizontal that will be your eye line. So it is only man-made horizontal surfaces that go to the eye line, for anything else it is better to use the angle finder.

Now let's consider a street with two rows of terrace houses down each side. The first thing we must do is put in our eye line. This is followed by a vanishing point and because both rows of houses are in line and parallel they go to just the one vanishing point.

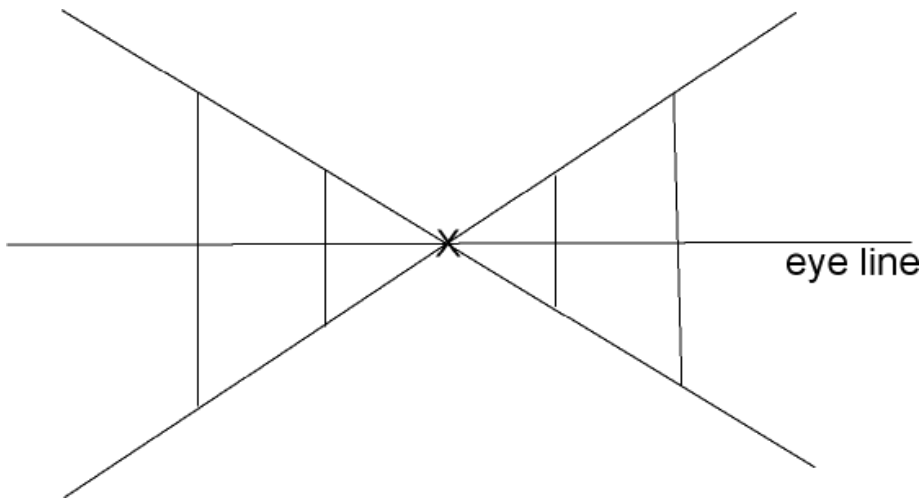

In this picture our eyes were half way up the nearest building. If we were to lay on the ground making the ground our eyeline, we can see that all the lines go down to the vanishing point, and none are going up to it.

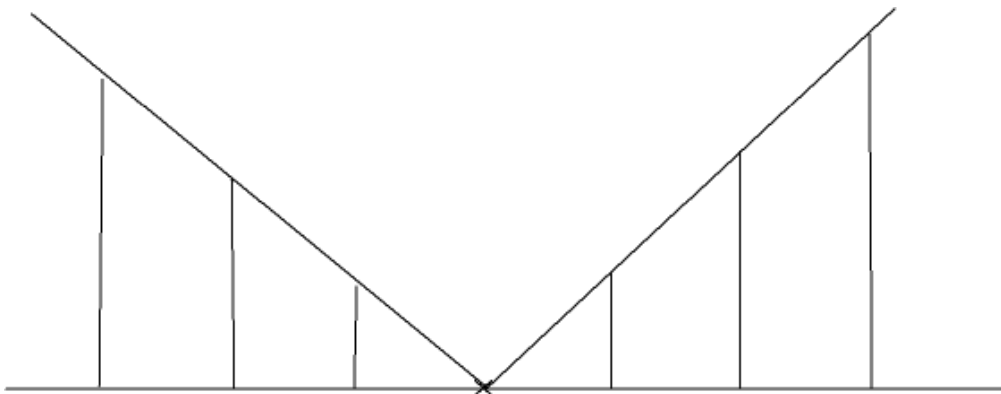

What happens when we have row of houses going round a corner? The houses are now not in line and so all go to their own individual vanishing point. The closer the vanishing point is to the building the more acute the angle is to the viewer. In the sketches below we can see the houses are going away from us left to right and so the gutter lines will fall left to right. We can see the houses are going around a right-hand corner but the last house on the line then goes round the left-hand corner, all done by moving the vanishing point towards or away from the buildings. So in a situation like this the vanishing point must be gathered for each building and this is where the angle finder is very useful.



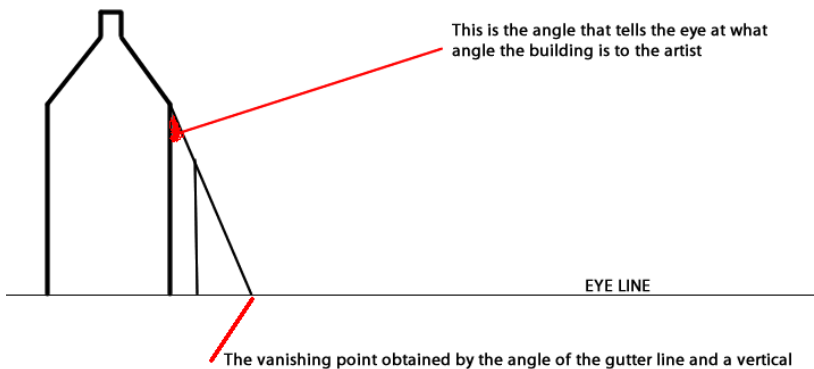

In the diagram above the angle shown in red is the important measurement and can be obtained by using the angle finder, but after some practise you will learn to draw these angles by eye. It is this angle that fixes the vanishing point on the eye line and sets the angle of the building relative to the artist.



Now we can start with our rows of houses going round a corner. With the first house and it can be seen that we are looking at the face from a very tight angle.

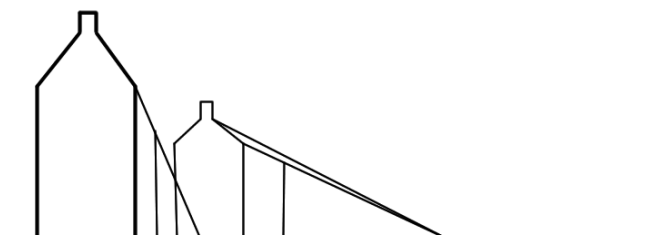

We now put our second house in a little further round the corner and as you see this effect is given by moving the vanishing

point a little further away from their house which has the effect of turning the house further around to face us.

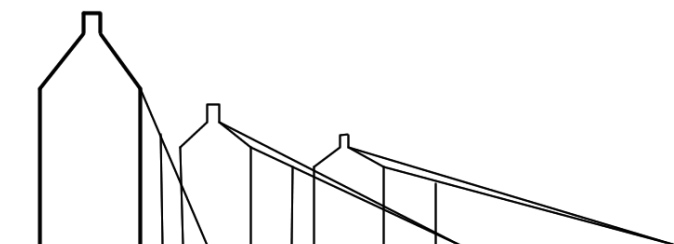

The house is now positioned and the vanishing point is moved even further away and so the third house has gone even further around a right-hand corner.

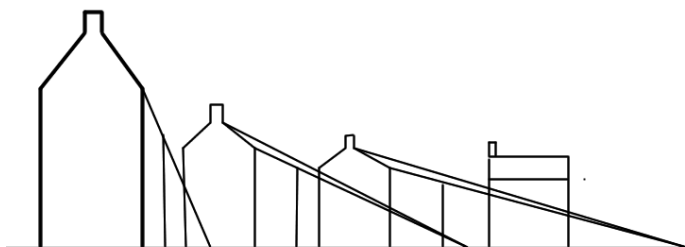

In our next diagram I have put a house that is square on to us and so it does not have a vanishing point and all the angles are at 90 degrees.

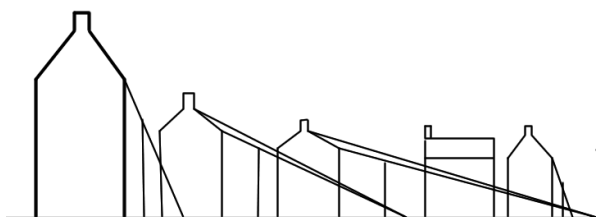

In this diagram the fifth house has gone around the left-hand corner and again is at a very tight angle to us.

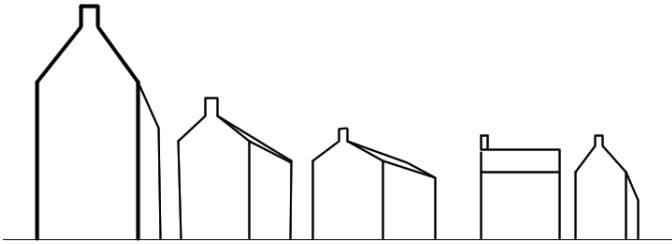

Removing all the construction lines you can now see that all the houses are at different angles relative to the artist.

One strange effect of perspective is that distances that are actually equal get closer with distance. This can be seen with these equally spaced telegraph poles. As they recede not only do they get smaller but they get closer together. How would we go about getting something to look right as they disappear into the distance? If we look at the diagram below we start with our eye line (1) as normal and put in our first post (2). We would then use our angle finder to get the angle from the first vertical poles across the top of the other poles and down to the vanishing point (3) of the poles. We would then estimate the distance from the first pole to the second (4). Then join the bottom of the first pole to the top of the second with a diagonal (5). We would then draw a line parallel to the diagonal from the bottom of the second pole to the line that goes to the vanishing point (6), this positions our third pole and is repeated for the number of poles required.



If we now remove the construction lines we can see that the poles disappear into the distance with correct spacing.

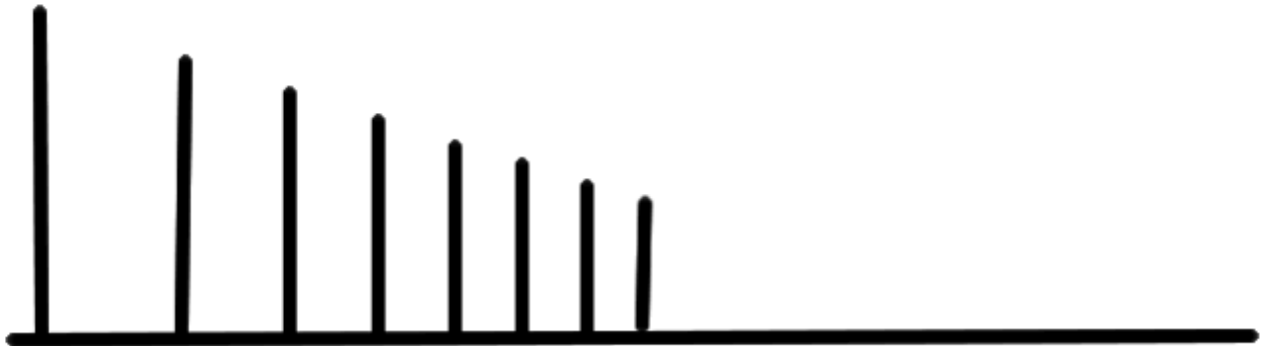

The image above was drawn with the eye line at the bottom of the posts as if we were laid on the ground to draw them. If we stood up our line would move up the polls by a certain amount depending on how tall we are (this is an arbitrary value)

Tip..... the positioning of the first two posts is again an arbitrary value, it will just increase or decrease the total number of posts.

Below I have drawn the starting point for you. I have drawn in the eye line followed by the largest pole and I then drew from the largest pole down to the vanishing point and put in the second pole. Now, see if you can complete the rest of the poles. If you draw this onto a piece of paper with pencil you can then rub out all the construction lines and be left with the poles correctly positioned.

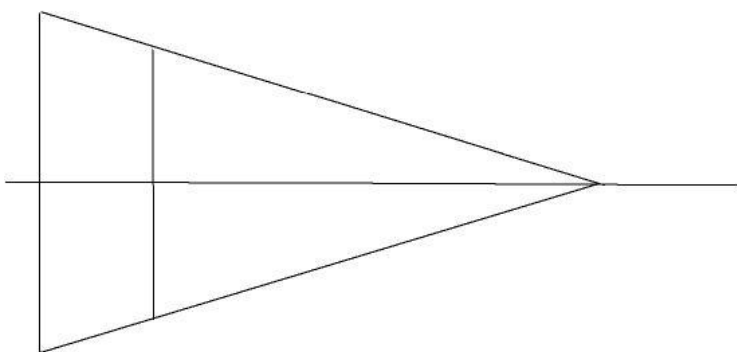

There are times we don't want this amount of accuracy and it is better to be a little bit looser, but it is for you to judge whether you want the accuracy or the looseness.

Now let us look at the paved area. It is exactly the same as with the poles but turned through 90°. Again we start with the eye line and vanishing point then draw our lines to the vanishing point, estimate the size of the first row of tiles and put in our diagonal. We then draw the horizontal across the top of the diagonal, this gives us our second row of tiles. We then again put a line parallel to our diagonal and draw the horizontal at the top of it, this gives us our third row and so on until the tiles are finished. Immediately it can be seen at the tiles to look as though they disappear into the distance and not left to guesswork.

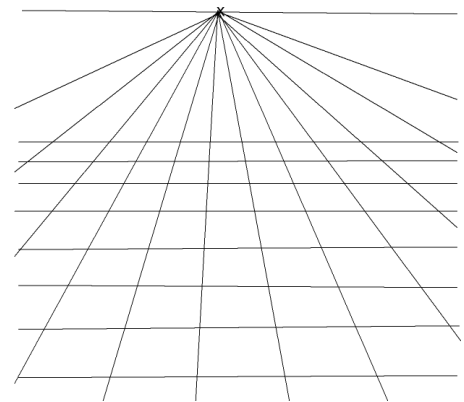
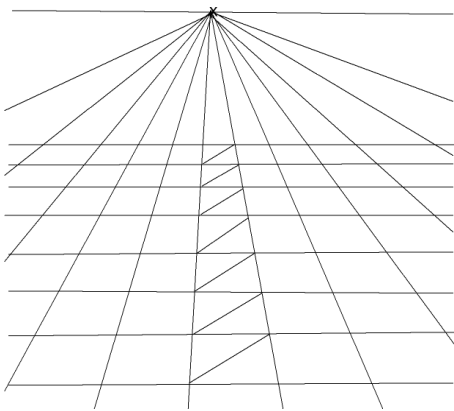

If we wanted to put a chair on these tiles all the lines of the chair must go to the vanishing point of the floor because the chair is relative to the floor. So often I see in paintings where the rules are not being followed and the chair often looks as though it is floating or at least resting on the floor at a strange angle. If you look at the chair, some of the lengths and angles seem very extreme and there is a temptation to draw them as your mind tells you, but ignore that, work from the basics of perspective and it will always look correct. You will be amazed how steep some of these angles can look, and yet you may well see them as much flatter because your mind says that they are horizontal surfaces, hence the old saying, paint with your eyes not with your brain.

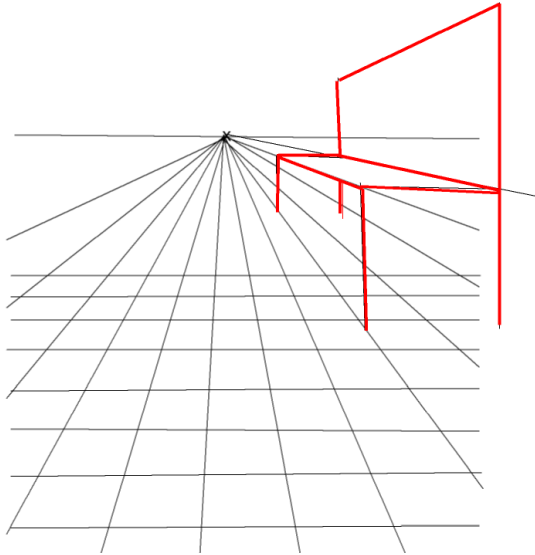

In the diagram above if you look at the chair the angles look very extreme and some measurements such as the difference between the near legs and the distant ones are so different that you would think they just cannot be right. In the finished sketch they look correct and that is all that matters. At first perspective will seem extremely difficult, but once you get the basics you will find it so easy.

Many students have problems drawing the gable end of the building. Because of perspective the centre of the building (at the point below the apex of the roof ) is not actually central (as we have seen in the previous chapter equal distance will appear closer as they go away). We can think of the gable end as having two centres, one is the real centre, if we were square on to the gable end the apex of the roof would be equal distant from the left and the right of the building. The other centre

is the visual centre , because of perspective the distance between the front edge and the centre is greater than the distance from the centre and the back corner of the building because of perspective shortening distances as

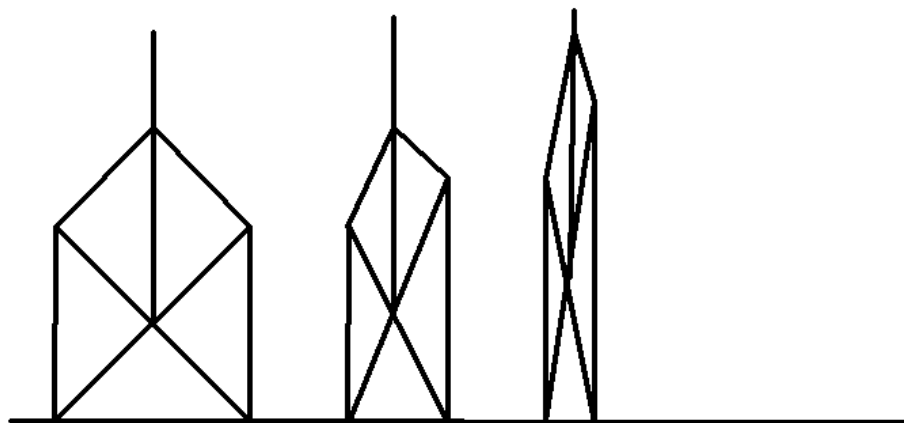

they go away from us. Many people try to make the perspective centre the same as the true centre and it looks completely wrong.

The best way of finding the perspective centre and not the true centre is to put the end of the building in and then join the corners with two diagonals and where the diagonals cross is the centre of that shape. This works when you are looking at the gable end from any angle. You can be square on to the gable end or even at a very extreme angle and the centre would be correct.

A vertical can now be drawn from the crossing point of the diagonals and the apex positioned anywhere on this vertical. We can see that one of the roof lines is longer than the other and many students try to make these the same length, again the end product looking totally wrong. The longer roofline is the true length, the other line is shorter as a result of foreshortening. Foreshortening is when you are looking up the length of a line and not square on to it. Try it, get somebody to stand in front of you with their arm outstretched and look at the length between their wrist and their elbow. Now tell them to bend their arm and bring their wrist round towards you. You will get to a point where their wrist is covering their elbow causing foreshortening. Of course they are still the same but we are now looking at it in a distorted way.

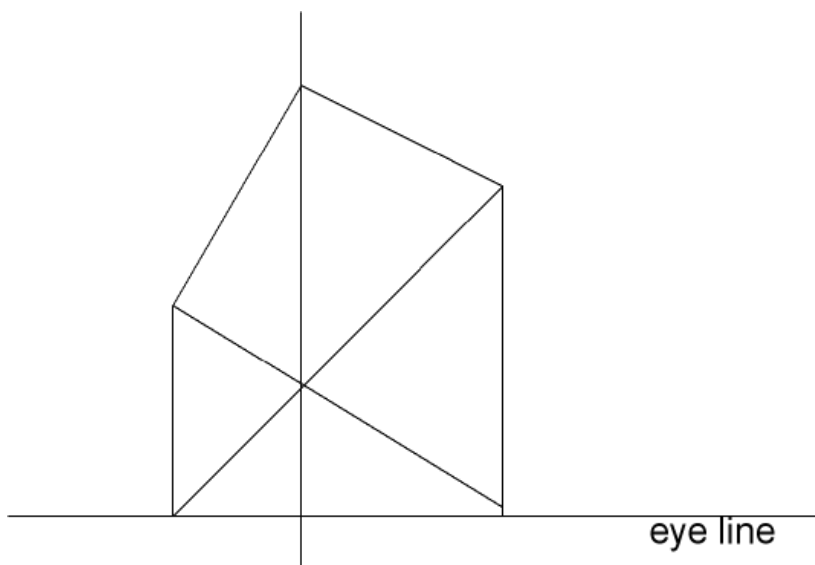

We have now seen the difference the eye line makes to the buildings. Let us consider we are halfway up the mountainside and there is a building in the valley and one on

top of the mountain. All the lines from the building on top of a mountain will come down to the eye line and all lines from the house in the valley will go up to the eye line.

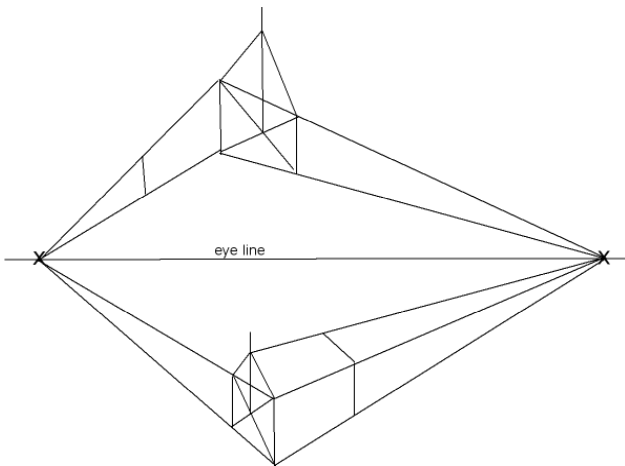

How do we get the apex and the distance roofline? If we look at the figure below we can see from the vanishing point that is relative to the gable end (x), a vertical line is drawn (4). Then the near roofline is taken up to intersect that vertical (5) this gives us a vanishing point for the roof (z). Now a line is taken from the far corner of the building up to this vanishing point (6), which gives us the angle of the distant end of the roof. We can see that the apex of the roof is not parallel to the gutter line, and the near and distant ends of the roof disappear to the vanishing point that belongs to the roof and are different and must not be drawn parallel. I see students trying to make these parallel and they look so wrong.

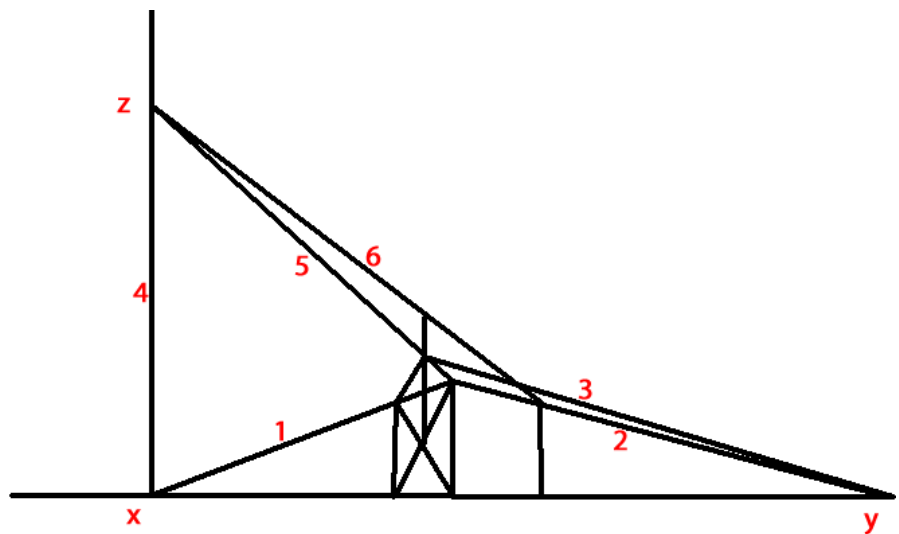

Once you get used to perspective you will not be drawing all these construction lines but it's important you understand that these lines are not parallel and as long as you draw them with a slight difference in angle they will look fine. So now the vanishing point of the roof is fixed. If we wanted to put a skylight in the roof, the verticals of



the skylight would go to the vanishing point that belongs to the roof while the horizontals would go down to the vanishing point on the eye line.

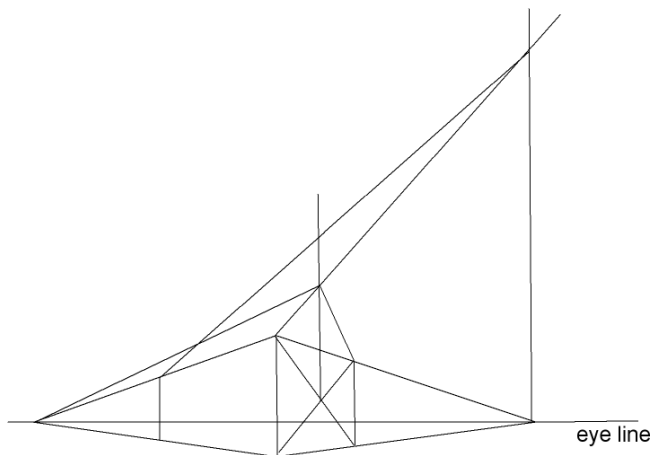

Here we have a picture of Boughton in the Water in the Cotswolds taken on one of my painting holidays. Have a go at putting the eye line in and then find the vanishing points for some of the houses. A clue here would be that I was seated when I took a photograph and look for things that you know are horizontal, like window sills, mortar lines, doors or gutter lines. Then using a ruler extend one of these down to the eye line to give you the vanishing point of that building, now check that all the other horizontals on that particular building go down to the same vanishing point.



Another way of finding the eye line is to extend any of the horizontal surfaces such as the top and the bottom of the window, the top of the door or the gutter line and where any two of these lines cross is the vanishing point. We know that the vanishing point must be on the eye line and therefore we now also have the eye line. You can use this in real life by taking two rulers and using these to extend any horizontal and where they cross is the vanishing point and eye line.

Once you have all the vanishing points in you can see each building has its own vanishing point, and the vanishing points for each building terminate on our eye line.

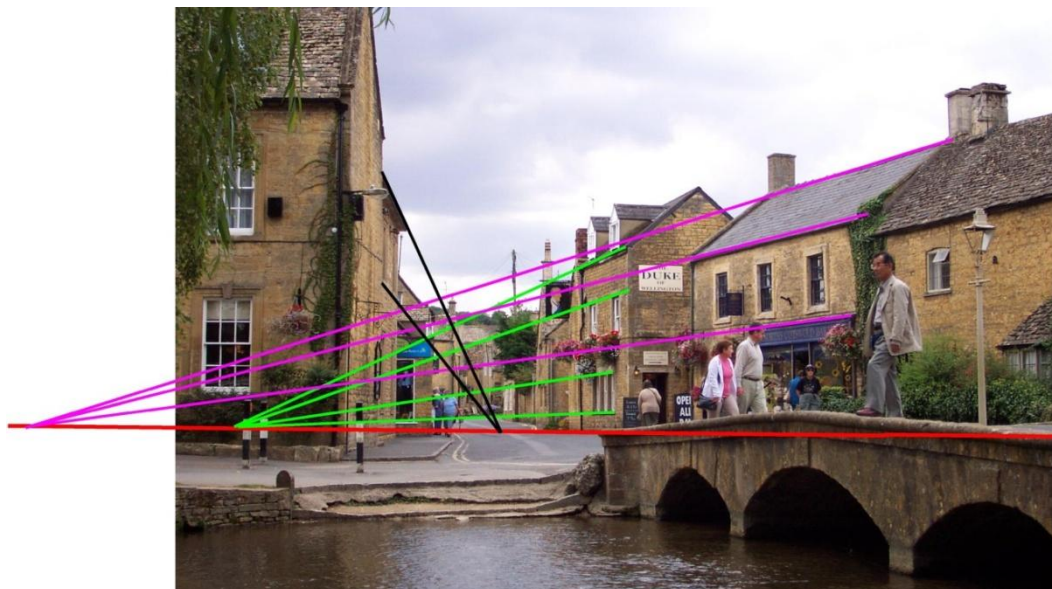

Below is the same picture that I have put in the eye line and the vanishing point for three of the buildings,( try not to look at these until you have added your own vanishing points to the picture above).

Now let us look at your results and compare them with the picture below. You can see in the picture below that the eye line (the red line) is quite low because I was seated. The vanishing point for the building second from the right is the violet vanishing point. The vanishing point of the building to the left of it is the green one. The black vanishing point is for the second building from the left. So you can see, we have at least three different vanishing points, but once we have the vanishing point for the building it is not a big problem then to get the windows and doors drawn in with the correct perspective. The violet vanishing point is not actually on the picture but as I have discussed if we have a rough idea where it is we can put our paper on the floor and with a bit of string and a peg we can ensure the correct perspective. You can see with the building on the left-hand side, that because it is square on of there is no perspective the gutter line and the windows are all horizontal, but if you look on the wall on the right of the building, it goes away from us at a very steep angle because that wall is at a very acute angle to us. So with perspective it is important you see each face as an individual shape

Now let's look at perspective lines in close-up. As you can see doing buildings in perspective is easy once you have the vanishing point. All you need to do is draw a few lines from the vanishing point and anything can be drawn in without a problem. It is obvious that the nearer the vanishing point is to the building the steeper the perspective lines and therefore the more acute angle the building is to us. Therefore, if you look at the picture you will see that, because the buildings aren't in line or parallel, they must all have their own vanishing point.

Below we can see another example of finding the correct perspective when the vanishing point runs off the paper. Again, lay your sketch on the floor and with the piece of string set out on the eye line (the green line) ensuring the string is parallel to the bottom of the paper. We now need to put a peg where the vanishing point is and tie our second piece of string to the peg. Now the loose end of that string can be moved up and down as shown with the other coloured lines (the yellow, blue, black and red lines) to give us the correct perspective on the building. It is worth noting

that this process only needs to be done when absolute accuracy in perspective is required, for example when the building is in the foreground and a main part of the picture. Nothing looks worse than bad perspective on a building that forms the main part of the picture.



So now, let us look at a situation again where correct perspective is very important. Below we have a photograph that I took at Robin Hoods Bay and also a pencil sketch that I made at the same time.

In the photograph you will see that we have converging verticals. Ignore this. The reason for it is that a wide-angle lens was used on the camera.

In the pencil sketch it is drawn correctly, another reason not to draw from photographs and only from real life. I cannot emphasize enough the importance of going out and sketching and not to take the easy way out and work from photographs. We see a building on the right-hand side that has two distinctly separate faces and it can be seen that this building turns a corner. Because of this the building has two vanishing points, one for each face. So the first thing we do is fix our eye line and it can be seen from the building on the right of the picture that the mortar lines come down right-to-left until we get to the step of the doorway which is horizontal so this is our eye line. So now we can take the gutter line from the near face and extend it down to the eye line, giving us the vanishing point for the nearer face. We can now take a line following the gutter line of the second face down to the eye line giving us the vanishing point for the second face. So now we can work from the vanishing point of each face and draw lines as shown in the sketch to give us the brickwork, windows and doorway. Doing this gives us the correct perspective for the building on the right.



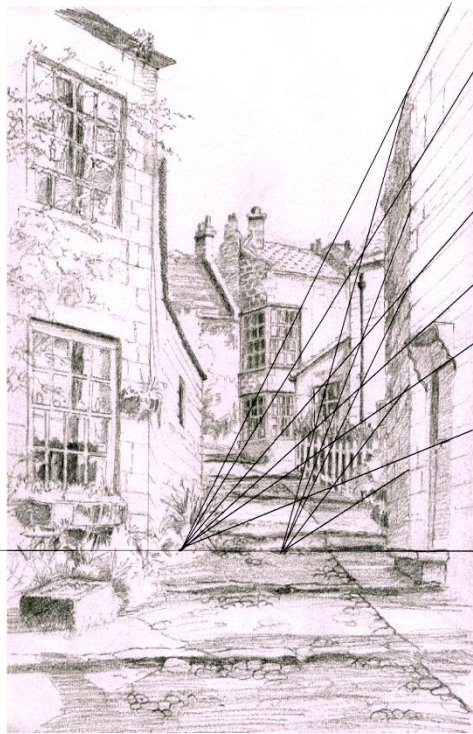

What happens now if we are painting a picture looking downhill. If we look at the picture below, you can see we are looking downhill, but what makes us think we are looking downhill.

So again we start by putting our eye line in the picture (using the mortar lines on the left-hand stone building). Now, if the road was horizontal it would go to a vanishing point on our natural eye line as we saw earlier, but if we look at markers on the road, the marks left by the road repairs, the curb, the bottom of the shops and the steps all go to another vanishing point that is not on our eye line. The vanishing point for the road is on the black line of the pub. So now we have a vanishing point that doesn't relate to the natural eye line which up to now we have always considered that a vanishing point must be on. In this case the vanishing point is below our eye line. Because this vanishing point is below our natural eye line it tells the eye that the road is going downhill.

If we look at the road repairs, the curb the bottom of the shops and the steps and extend lines from them we can see they all meet on the black line of the pub This is the vanishing point for the road and anything on the road such as people, manhole covers etc must all go to this vanishing point.

Now let us look at a situation where the road is running uphill.

If we look at the brickwork on the building on the right-hand side (ignoring the converging verticals caused by the wide-angle lens) we can see the mortar lines are coming down right-to-left until we get to the step into the doorway. This line of the step is horizontal telling us this is our eye line. If we now take lines from the bottom of the buildings from the paved area running up the hill we can see they emerge at the lower bay window of the distant house, this is our vanishing point for the road. We can now see the vanishing point for the road is above our natural eye line and therefore the road is running uphill.

How would we show a group of people going away into the distance in correct perspective. The first thing we have to consider is are we on level ground and are they as tall as me, if so their eye line is my eye line. If I now took a horizontal line from my eyes, the eye line would go through anybody else's eyes because we are all as tall as each other.

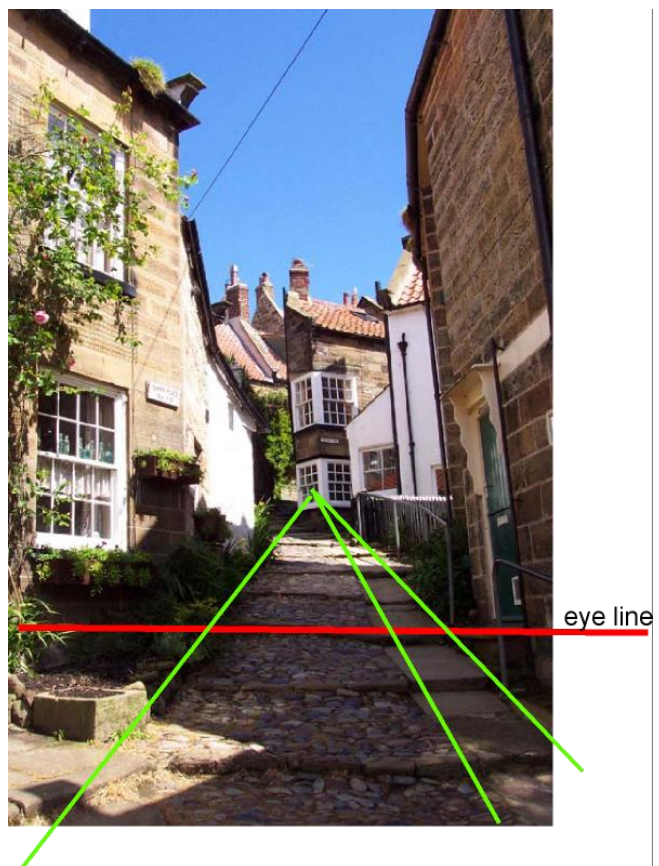

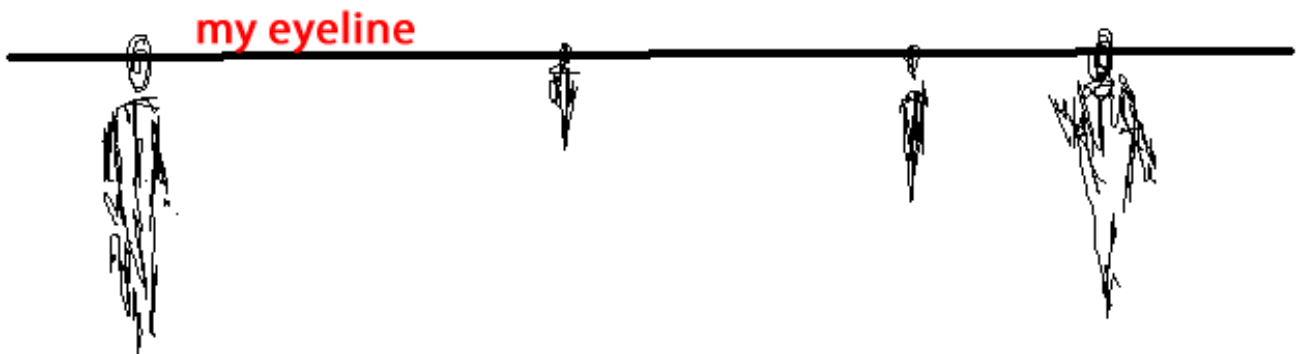

So now, if I put our eye line in the picture we can now start to add the other people. We will start by putting the person in the foreground, as his eye line is my eye line I position his eyes on the eye line.



Now if we had somebody way off in the distance his eye line is still my eye line and therefore again his eyes would be put on the eye line. The positioning of the feet is at your discretion it is a case of how far away do you want to show these people but one thing that doesn't alter is the eye line position.

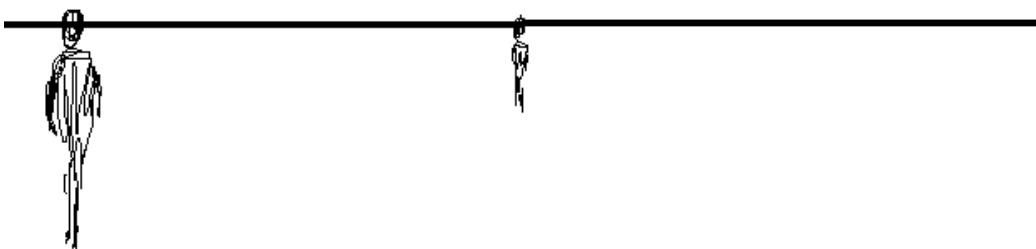

So now if we wanted to draw somebody between the two people and we wanted the third person approximately half way we would now join the feet of the nearest and distant person, and the third person is now drawn between the eye line and the line joining the feet.

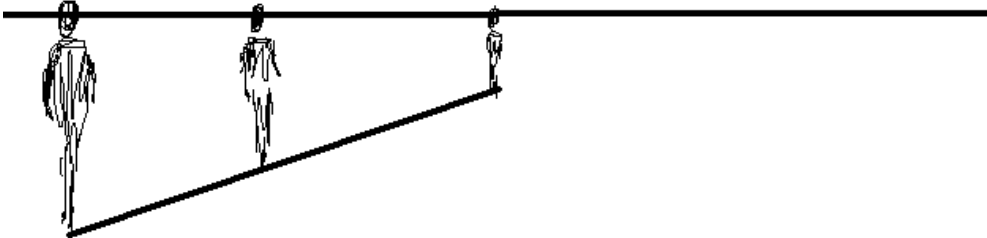

Now if we wanted to put somebody the same distance away as the middle person but offset to one side we would take a horizontal line from the person in the middle across to the position we want to place the third person and then draw them in between the eye line and the horizontal line.

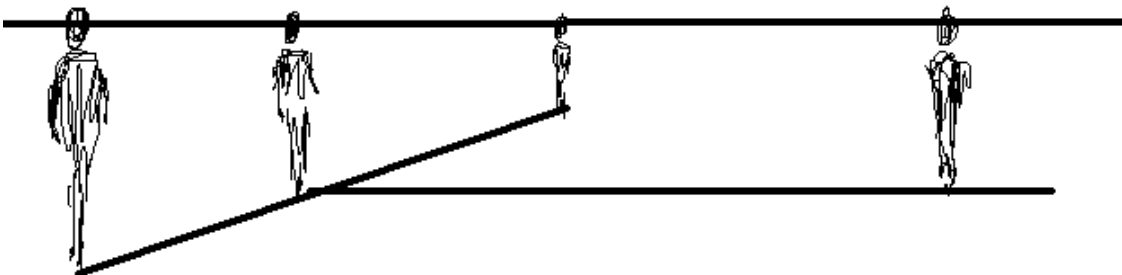

Up to now we have looked at everybody being as tall as each other, if we wanted to put a child in the picture we would make sure he is in the same plane as one of the other people to give a reference to work from but just drawn smaller. So now anybody looking at the picture would see that the child is in the same place as one of the other people but is smaller and therefore a child. So now the eye line is no longer relevant to the child because they never reach my eye line.



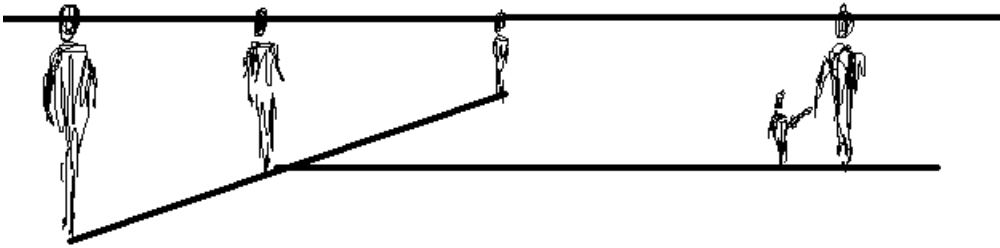

Let's look at people on an inclined plane. If we are looking downhill the further away they are the greater the distance they are from the eye line.

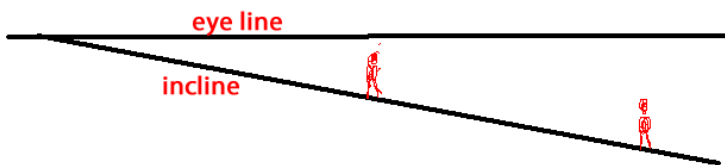

And because they are standing on the road they go to the vanishing point that belongs to the road. So anything on the road such as curbs, road repairs, or manhole covers they all are drawn to the road vanishing point.

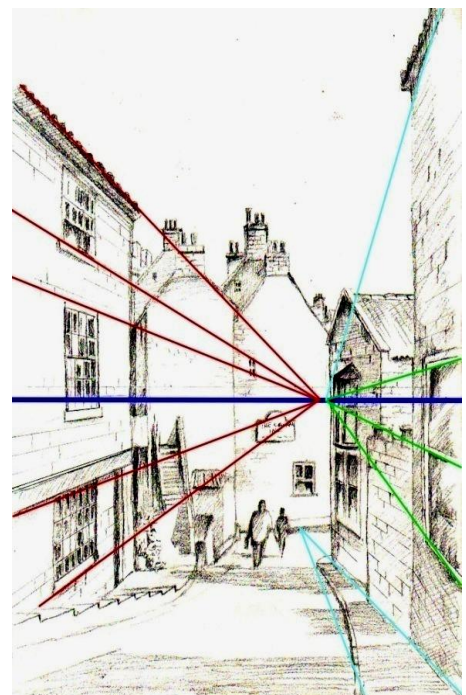

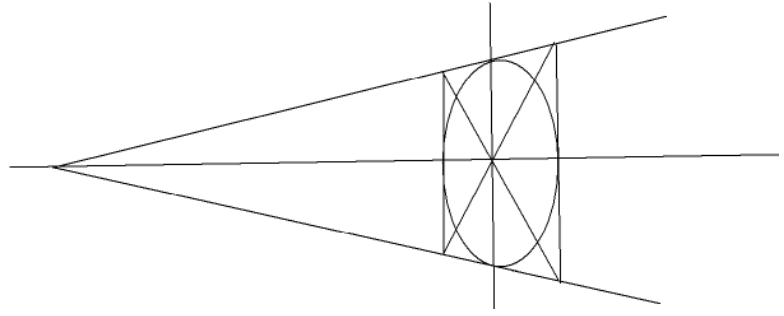

Let's now look at how to draw a circle. Because of perspective many people draw an oval which it isn't. The easiest way is to draw a box and put the circle inside that box using the basics of perspective. We need to find a centre of this box and as before this is done by drawing in the two diagonals. Then draw a line from the vanishing point through the centre and also a vertical through the centre. This now gives us four points of contact of the circle; the circle is then drawn in freehand. You can see the left-hand side of the circle is much flatter than the right and the circle is not a true ellipse as many draw. In this example we are looking at the circle with our eye line through the centre but it may be that the circle is above or below the eye line. If the circle is above the eye line we must draw the box above the eye line, followed by the diagonals to give us the centre of the shape then a vertical through the centre and a line from the vanishing point through the centre this again gives us the four points of contact of the circle.

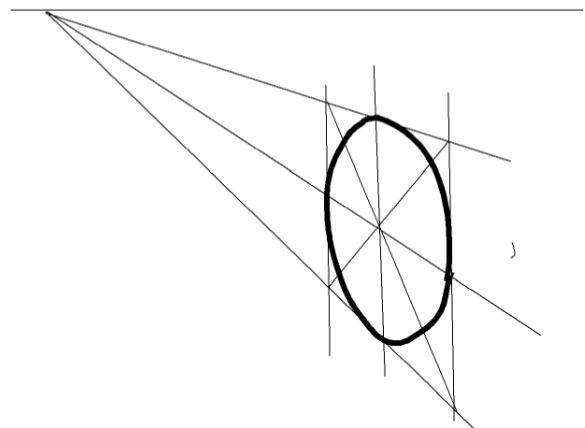
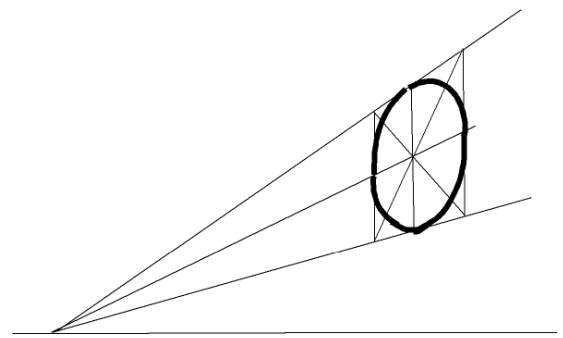

It is so much easier trying to draw a circle like this as you only have the four segments to sketch as against trying to get a complete circle in one go especially with it being distorted due to perspective.

Now let's look at a circle below the eye line but this time we draw the lines down to the box and again followed by the diagonals. We now draw a vertical through the crossing point and then a line from the vanishing point through the crossing point giving us the four points of contact points of the circle.

Now let's look at putting a circle on to a building as though it was a water wheel. The first thing we do is draw the wheel as before. Because the front of the wheel is parallel to the front of the building the building will go to the same vanishing point as the front of the wheel so this can be drawn in. We now need to put a vanishing point in for the right-hand side of the building. The middle of the wheel is parallel to the right-hand face of the building and so these again go to the same vanishing point.

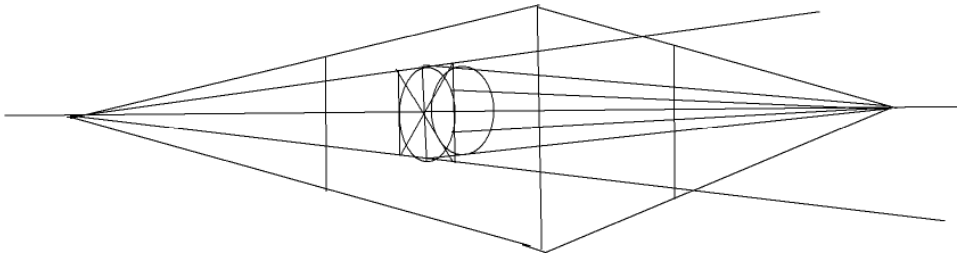

On removing all the construction lines, we can see in the drawing below that the wheel now looks attached to the building and not floating separately from it and this is purely because the same vanishing point of being used for the wheel and for the building.

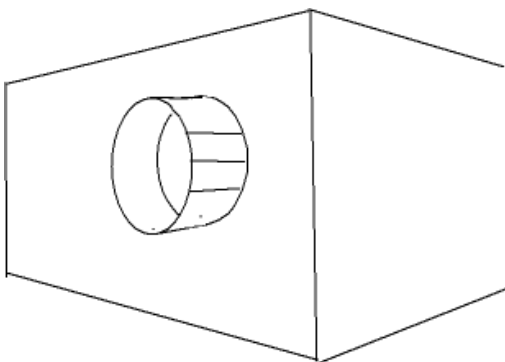

You can see how important the eye line is in the picture. If we were painting at the side of the river the vanishing point for the river must go to our eye line because the water is horizontal. If the vanishing point of that the river is above the eye line as we have seen from previous examples of roads, the river will go up hill. If the vanishing point of the river is below the eye line, the river will be going downhill as we have seen previously. Also if we have a lake in the picture it is important that the far bank of the lake is on the eye line (as long as we are standing on the bank of the lake). If we were standing on a hillside looking down on the lake then the distant bank of the

Lake would be below our eye line. The lake can never be above our eye line, unless we were drowning. It only takes a few minutes to find the eye line, so get into the habit of the first thing you do when you are comfortable and ready to start your sketch, fix the position of the eye line and put a cross on the drawing board or the gummed tape holding the paper. This way you have a quick reference as to the position of the eye line in the painting.

Now let's put a porch on a building. First we must consider what are the parallel faces and they are the front of the porch and the front of the building so they must go to the same vanishing point that belongs to the front of the building. The side of the porch and the side of the building they go to the vanishing point that belongs to the side of the building (see drawing below).

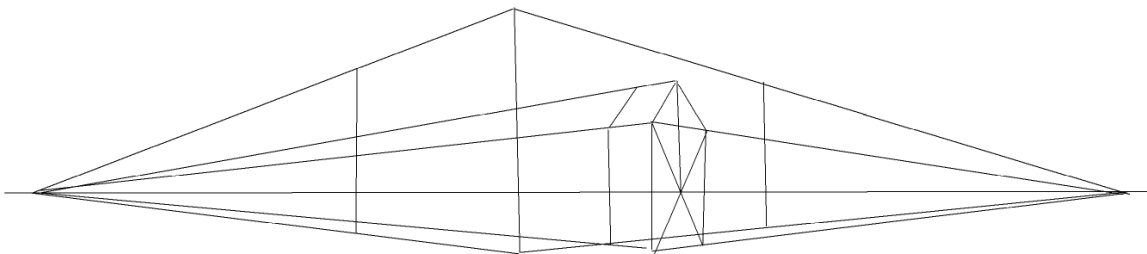

Now removing all the construction lines we can see that the porch looks attached to the building. So it is important in perspective that we consider parallel faces, all faces that are in line or parallel must go to the same vanishing point.

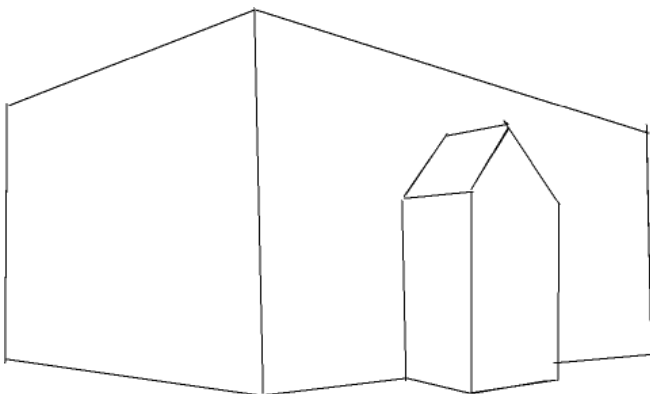

## THE KEY MEASURE.

In the comedy movie we see the artist with his arm outstretched and his thumb stuck up, but he's not checking his nail varnish or thumbing a lift, he is using the key measure. It is impossible to use your thumb for this. Some people use pencils or brushes, but I like to use a wooden meat skewer because it's easy to make a pencil mark on it and also has a sharp and blunt end which have a particular use. The key measure is useful not only in the landscape but also in portraiture, life drawing and still life. The key measure is all about taking a standard measurement within a scene and comparing it to all the others throughout the scene

It is not only useful for getting a single item the correct shape, it can also be used to get everything we see in our selected scene down onto a sheet of paper. On many of our trips out of doors we get the comment how on earth do I get all that down onto my sheet of paper and we can do it by using the key measure. Also people will start their sketch and before they have their entire picture, they have found they've run out of paper and so start rubbing out to fit things in. All this does is cause confusion and ruin the paper.

So first of all we must learn the process of taking a measure. Every time we make a measure the skewer must remain vertical, our shoulders must remain parallel to the scene we are painting and our elbow must be locked straight. All this is done to ensure that our skewer stays the same distance from our eyes every time we take a measure. If our arm is not straight this will create different distances from our eyes and so the measure will not be constant. If our shoulders are not square to the scene, then again the distance from our eyes can vary. If we are right handed we must measure with our left and draw with our right, this avoids getting our arms tied up in a knots through changing from pencil to skewer. Keep the little finger of the left hand towards us on the same side as the thumb, this keeps the skewer vertical.



If you look closely you can see that because I am taking a real-life measure I am using the blunt end of the skewer and on the skewer you can see the real-life key measure divided into quarters. It is important you always get the correct end of the skewer but after a bit of practise as you lift the skewer up to take a measure automatically you will look to

see that that you are using the blunt end. You can also see that my little finger and thumb at the side of the skewer, doing this keeps the skewer vertical.

The scene can be as big as you like but with a key measure you can always fit it on your paper. Gone are the days that you are halfway through your sketch and you have run out of paper. The first thing you need to do is compose your picture using a picture finder. You can buy picture finders, but all you'll need is a square cut out of a piece of mount card. It is important that you follow the same format as the paper you are using i.e. the length against the height is the same ratio. A quarter Imperial sheet of paper is 28 cm x 38cm so you could cut out the square 2.8" x 3.8". When you look through the picture finder the picture you see will be exactly the same format as the paper. Moving the picture finder closer or further away from your eyes enables you to select how much of the scene you want in the picture and anything you don't want is masked by the card so you get a very good idea of how your painting will turn out.

The first thing we need to do is to fix the limits of our painting using a picture finder or other tool to fix the limits of the scene. First of all fix the left-hand limit. It might be a flower, a tree or a gate, anything that you can see easily. You will now select the right-hand limit again looking for something that stands out from everything else. From now on I will call the scene we are painting the real image and the one on our paper the paper image.

For the real life measure we use the blunt end of the skewer and whenever we work on our painting we will use the sharp end on the paper image. This is where the skewer is very useful. If I was to drop my skewer the moment I pick it up I know which end is the real-life measure and which is the paper key measure. It is very important you remember which end is which. You must avoid at all costs using the blunt end on the paper and the sharp end on the real-life measure, the results can be disastrous. I tell the students that they are using the blunt end in the real-life measure so as not to stab somebody in the hope it will help them to remember which end is which.

We now have to select a line that we are going to use as the key measure in the real image. This can be any horizontal, vertical or diagonal line look for a measurement that is repeated throughout the scene that is not too small or too big. If you use a measurement that you can see is repeated throughout the scene it makes the key

measure so much easier to use and cuts out guessing fractions of a key measure. This measurement is now put on the blunt end of the skewer (the real-life key measure). We now see how many times that key measure goes between the left and right limits of our real image. This gives us the ratio of the key measure to a full picture and the paper now has to be divided up into this same number. This now gives us the paper key measure and this measurement is put on the sharp end of the skewer.

Now you can see the reason for using something like the skewer with the blunt end as our real-life key measure and the sharp end as the measurement on the paper. We use the blunt end of the skewer when taking readings from real life and the sharp end when working on the paper. So for the mathematical amongst you what we are doing in the real-life key measure is taking a measurement and seeing what ratio it is to the full image i.e. left limit to right limit. We then reverse the process and use the number we have just obtained by dividing the real-life key measure into the scene and divide our paper into that same number giving us our paper key measure. That is the most difficult part of the whole process completed and we have our two key measures. We now divide our two key measures on the skewer into quarters which helps us to obtain fractions of a key measure easily and cuts out a lot of guesswork.

Nearly everybody I teach the key measure to has problems with this particular part of the process, but once they've got it they are absolutely delighted how useful the key measure is when sketching out of doors.



Here we have a church tower and we want to reproduce this in a painting so first we pick our key measure (shown in red) which in this case is going to be the width of the

tower. We then see how many times this width goes into the height and in this case it's three times. So now if we put a line down on the sketch (in red), the length of this line will give the overall height of the church tower (shown in black, it is three times the red line). The smaller we make a key measure the smaller the overall height of the church will be. The larger we make the key measure then the higher will be the overall height of the church. So in the figure on the right I have made the width of the church (the key measure) larger than the sketch on the left and therefore the overall size is bigger. So we finish with the tower being exactly the same shape and proportions as the original but larger.

What we are doing is comparing one measurement with another. It is not absolutely accurate because we may need to estimate a quarter, a half or three quarters of a key measure but it is close enough to give a good likeness. The key measure is a very useful tool in many forms of art. It can be used in landscape, still life, portraiture or life drawing; it is all about comparing one measurement with another.

Looking at this picture of an old barn the first thing we need to do is sort out our key measure. If we use the width of one of the windows that would go into the length of the building too many times. So any small error in the key measure would be multiplied by however many times it goes into the length of the building. If we took the length of the building as the key measure then if we took a measurement of one of the windows, the window will be divided into the key measure too many times and as before, any error would be multiplied. So we are looking for a measurement that is repeated throughout the building. A good one would be the height from the floor to the gutter line shown in red on the photograph below, as this measurement will go into the width of the building about three times; from the gutter line to the apex about once, and from the right-hand edge of the building to the window on the right about once. It is repeated throughout the scene and is a good key measure. Now if we take





that key measure and measure across the building (the green lines) we can see from one end of the building to the protruding wall is about two and three-quarter key measures. If we now measure from the right-hand edge of the building to the left hand side of the small



window, we find it is just less than one key measure (shown with the first white line). From the left of that window we measure to the doorway and find that between the left-hand side of the window and the left-hand side of the doorway is one key measure. Now if we go from the left-hand side of the doorway to the left hand window, the left-hand side of the window is about half the key measure. Now try on your own to decide the measurement from from the gutter line to the apex of the roof.

The answer to the question above is about three quarters of a key measure.

You can see that using the key measure you get all the proportions correct. If somebody had a house that was very long horizontally and you painted it tall vertically he would not be very happy and I don't think you would see any payment. Now go out and look at your house and using the skewer try getting the proportions and putting them down on paper.

Here we have a picture of Robin Hood's Bay. If we imagine we are sitting there and this is the scene we see through the picture finder (there is a pub in the picture, you must resist the temptation). We now have the outer limits of the picture set with the left limit just to the left of the windows on the stone building and the right limit midway through the windows of the right-hand building (it is important we remember our left and right limits). We now need to select what we are going to use for a key measure.



We don't want anything too small because then we would be dividing it into a large measurement too many times, and we don't want one too large otherwise will be dividing a small measurement into it a large number of times and so any inaccuracy in our key measure would be multiplied. The measurement horizontally across the pub will be a good measurement to use. If we look at the width of the pub, it is approximately the same as the width of the stone house on the left, approximately the same as the first white house from the left etc, the more key measures we can see throughout the real scene the more successful the key measure will be. The key measure can be any line in our scene and can be horizontal, vertical or diagonal it doesn't matter. What we are looking at is our measurement compared with our overall image (the distance between our left and right limits). So the same thing happens if we took a diagonal we are still looking at that ratio between our key measure and our overall scene.

Use the blunt side of the skewer to take this measurement (the green line), so the blunt end of the skewer now has the real life measure on it. See how many times this measure goes into the overall width of the picture, limit to limit. In this case it is about four and a half. Divide this measurement into quarters on the skewer to help with measurements less than a key measure.

The line showing the key measure of all the buildings is put on the eye line so you can see both the eye line and the key measures it would not necessarily need to be done this way in a painting.



This number is very important as we use it to divide our paper into four and a half and the measurement obtained is our key measure on the paper which is marked on the sharp end of our skewer (also divided into quarters). Now most of the work is done. We have a mark on the blunt end which is our real-life key measure and a mark on the sharp end which is our paper key measure (please remember which is which). It is always up to this point that most of the students have problems, so I would advise you read this paragraph a few times until you are totally happy with it.

Now, we can now start work on our painting using the key measure. I find it best to put a few verticals in the picture and this will prove that the key measure is correct.

We can now take our first measurement, from the left-hand limit of the scene to the right-hand side of the stone building on the left (the red line). It turns out to be just under a key measure (relative to the green line, the real life key measure), so now we turn the skewer around and with the sharp end (the paper end key measure) we make a mark just less than a key measure from the left-hand side of the paper. We can now take a measure from the right-hand side of the stone building to the right-hand side of the first white building (the yellow line) using the blunt end (the real life key measure). Again it turns out to be about one key measure so turning the skewer around we put one key measure with the sharp end on the paper next to the first.

The next building we know is a key measure because that is where we got our key measure (the green line) so we can place a key measure for the second white building. Now we're going to take a measurement from the right of the key measure building to the left of the tall building (the white line) we find this to be three quarters of a key measure. Up to now the measurements have being very kind to us and turned out to be around a key measure but there are times fractions of a key measure can be involved and that is why we divided the key measure on the skewer into quarters. We can measure down to the accuracy of a quarter of a key measure.

The distance left (the violet line) should automatically be the correct distance if everything has worked out okay. So you now know everything will fit in your painting and you won't be running out of paper before completing the scene you wanted as seen in the picture finder. Now we have the key points of these verticals in the picture we can position the horizontals. We would look at putting our eye line in the picture and if we measure from the top of the picture down to horizontal course of mortar on the stone building on the left (our eye line), we find it is three key measures down and we can put a small cross on the drawing board as an indication. We can now measure up from the eye line to the gutter line on the right of the stone building and using the angle finder to find the angle of the gutter line to the buildings vertical and place that on our sketch.

We can now work on some of the horizontals, from the bottom of the picture up, or from both sides of the eye line.

Please note, in my sketch I reduced the amount of foreground road that you can see in the photograph. This was done by lowering my eye line on the sketch so when I work from it the bottom of the steps is close to the bottom of the picture. This gives me more sky than road making the painting much more interesting as a nice sky is much more attractive than a lump of tarmac.

Here I am using the angle finder to get an angle from a photograph. This angle is then put onto my sketch. I use one leg of the angle finder on any known vertical the other is then adjusted to whatever line I require. This is very useful if the vanishing point of the building is off our page. It takes a little practise holding the verticals still while you adjust the other leg but it does save you using the string method or guesswork to get you the correct angle.

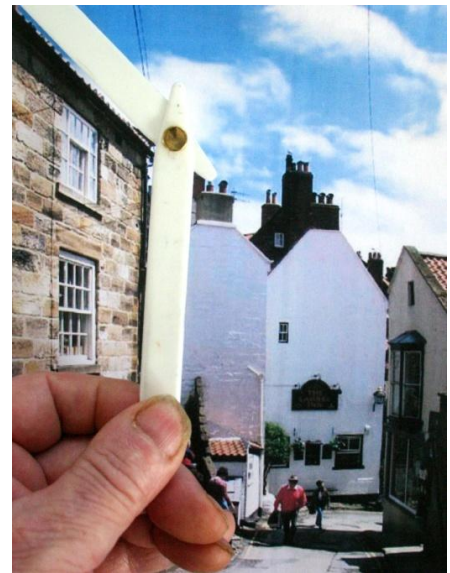

Once we have put the gutter line on the sketch we can extend that down to where the eye line would be and put our vanishing point in for the stone building. Once we have the gutter line we can measure from the gutter to the bottom of the window on the stone building put that in and take it down to the vanishing point.



This procedure is done for all the other windows and doors on the stone building. Looking now at the next building all we need to do is measure from the gutter line of the first building down and it gives us the point of contact for the gable end of the first white building so when you have fixed point you can work from this fixed point.

The eye line we put in earlier runs right through the picture and can be used to measure distances above or below it. This method of measuring is used for the rest of the picture before doing a little bit more sketching in detail with the comfort of knowing everything will fit in okay. People say it is a little mechanical, which it is, but once you have got a few basic lines in, you are free to expand on the picture to whatever point you want, and gone are the days of running out of paper.



With a portrait you could use the distance between the iris of the eyes as the key measure, then measure from the bridge of the nose to the bottom of the nose, from the bridge of the nose down to the mouth, and then from the bridge of the nose down to the chin. It is all a case of comparing one measurement to another. In life drawing you could use the distance from the forearm to the wrist which is about the same as from the elbow to the shoulder and also shoulder to shoulder. So what you are doing is either scaling up or scaling down depending on the measurement on either end of the skewer. If the measurement on the blunt end is half that of the sharp end then you will double the size of the sketch from the photograph. If the sharp end and the blunt are the same there will be no increase or decrease in the size of the image. When you are drawing from real life it is still exactly the same, the only difference being you use the picture finder to say how much of the picture you want to keep in the sketch, whereas with a photograph the border of the photograph dictates what you are going to put in.

No matter what your sketching the key measure is a very useful tool. It can be used in portraits, still life or life drawing, the same technique can be used for everything. It takes a little coming to terms with, and like everything you just have to persevere.

Compare the photograph below with the sketch below of the same scene. With a bamboo meat skewer, or anything that has distinct ends, on the blunt end put the key measure from the photograph (the key measure is shown in red). Then on the

sharp end do the same with my sketch below again shown as a red line, divide these two key measures into quarters to help you with fractions of a key measure and then compare measurements from the two making sure you use the correct end of the skewer.

**Please note** .....The blunt end for the real life image in this case is the photograph, and the sharp end for the sketch. If you were sketching out of doors it will be exactly the same process, the blunt end for taking measurements from real life and the sharp end on your paper.



Now have a go at doing this yourself using the above as a guide. You could use the photograph as your real scene and the pub as your key measure then depending on the size of the paper you are using for your sketch see how many times the key measure goes into the width of the whole scene of the photograph. Then divide your paper into this number thus giving you your key measure on the sharp end. Don't forget, when you are working on the photograph use the blunt end, and when working on your sketch use the sharp end (most important!).

Give it a try, once you have done a couple of sketches using the key measure you will find it is a very useful tool and worth persevering with.

## COMPOSITION

Composition is another very important part of the painting. If we look at our picture finder we can see it is divided into three vertically and horizontally. We aim to put our focal point on to one of these intersections so you can have a focal point in the top left of your picture, the top right, the bottom left or the bottom right. The focal point can be anything; it can be an area of contrast, colour or sharpness. It is important that when studying your landscape before you start your painting that you select a focal point and position that focal point on one of the intersections. If you were looking out to sea at a yacht, you would aim to put it and as a focal point on one of the intersections. It could also be a brightly coloured door on a house amongst a group of houses or a farm amongst the rolling hills.

The picture finder is showing the Golden thirds. The aim, is to put your focal point on one of these intersections.

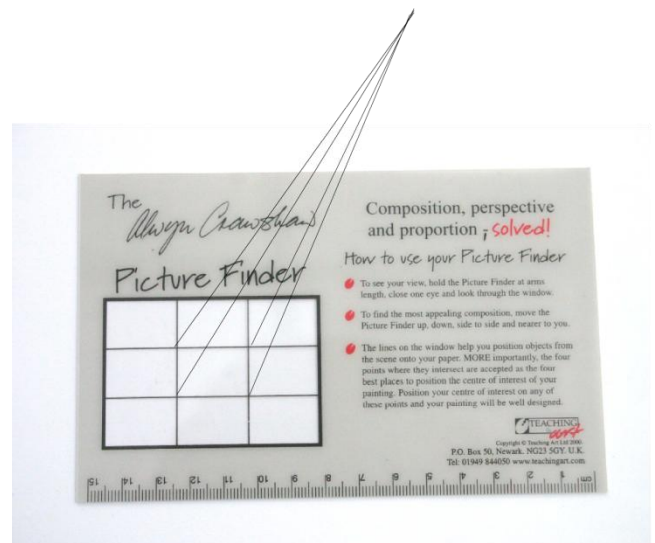

When putting a boat or a horse in a picture, make sure it is going towards the centre of the picture and not out of it. The same with a road. Don't have the road going into the picture then turning a corner and going out of the picture at one side. You must stop the road from going out of the picture and this can be done by having it go behind a bank or a large tree, anything to break the course of the road leading the eye out of the picture. If you have a number of buildings in the picture, don't separate them all. Try and have them overlapping wherever possible, it stops the painting from looking too disjointed. You can see how this works by setting up a small still life with some fruit. Separating all the items just does not look correct, but having them overlapping even slightly is much better composition.





Looking at the pictures above of Thirlmere in the Lake District, we see from the picture on the left that the wall across the front of the picture is a continuous one. Having the continuous wall or fence running across the bottom of the picture is not good composition it acts as a barrier to the eye going into the picture. I improved the composition of the picture by creating gaps in the wall and by putting in a gate. I then decided I didn't like the wall across the front anyway and so I just put small indications of where the wall had been (picture on the right) and along with a few extra trees produced my final composition.

The essence of the picture is still there. It is still Thirlmere but with a few little bits of artistic license the picture now tells a story and is much more interesting. Putting the pathway into the picture also leads the eye through the foreground into the middle distance and on to the mountains beyond. After all, who is going to take your painting to Thirlmere just to have a look at how accurate the painting is. I don't think many people would go to the trouble when all they want is a nice attractive painting on the wall.

Also if you're painting a picture of a river from a hilltop or cliff edge, put a small piece of land in the foreground to stop that feeling of floating in the picture or standing in a river getting wet. After all how often do you go flying round the landscape or standing in the middle of a river, I suspect not very often.

In this painting of Langdale Pike in the Lake District the building on the bottom right-hand third was in actual fact way off to the right of the picture but I brought it in and introduced it in the picture. Notice how it is in the bottom right-hand third making it a good focal point. A feeling of distance was needed between the



cottage and Langdale Pike so indications of a few fields and small trees are shown to give this distance. Without them the mountains would rise directly from behind the house and therefore would look much smaller, only two or three times higher than the house.

By putting the fields in, the mountains look much bigger. Whenever possible try to do all your work out of doors. A camera is not a good way of capturing a scene as we have mentioned before. Below you will see a photograph I took of Langdale Pike and above the sketch I made from exactly the same location, below you can see the camera lens has pushed the mountains back and they look much less imposing. The sketch has much more feeling about it and when I ask many of the students which they would rather paint from, they often say the sketch. Please note the fence going across the bottom of the photograph. Again this was left out in the sketch. You can also see the house in the right-hand side of the photograph which was brought in to the final sketch, positioning it on the bottom right-hand third.



Also never position your horizon in the centre of the painting, it is much better to have the horizon close to the top or bottom of the picture. If you were painting in Norfolk where the landscape is very flat you would place the horizon towards the

bottom third of the picture throwing the emphasis on to the sky. If you were painting from a cliff edge looking down to the cliff face, then the horizon would be much higher in the picture around the top third. This way you will get the feeling of looking down into the picture. If there is a tree, a church or any tall building try to avoid putting these in the centre of the picture as this would have the effect of splitting the picture in two.



In the picture above of St Petrox church in Pembrokeshire, you can see how the church tower has being moved slightly left of centre and all the interest of the lower part of the church is in the bottom left-hand third of the picture.

So yet again, it is all about the preplanning of the painting. A few minutes before we start is all it takes, but a few minutes can be the difference between a good painting and a bad one. I know many people say that watercolour painting shouldn't be too technical, and to a degree I agree, but then I say you cannot discard what has being built up over many years by brilliant artists just because it is technical, and where do you draw the line. Spend as much time as possible studying paintings from the old Masters and look how it was done and things we have discussed in this chapter. They may seem very small things but they are so important. So don't, in your eagerness, jump out of the car and immediately start painting, take time out to study your

subject and don't be shy in altering something if you feel it would improve your painting. It is too late when your painting is finished to say 'I wish I'd altered that!

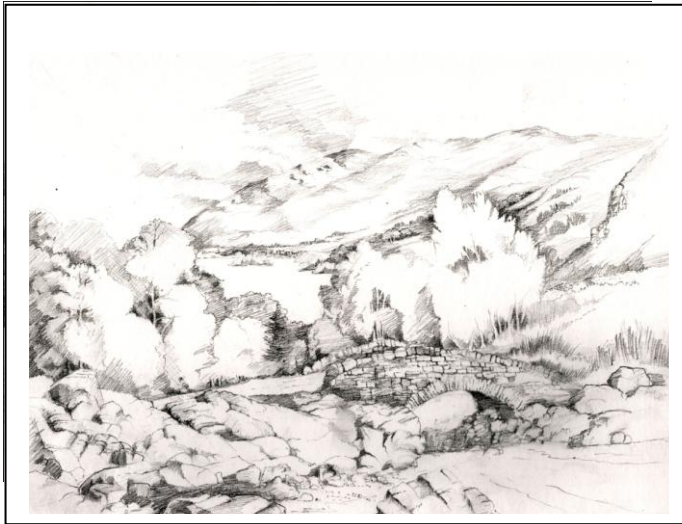

With this picture of Ashness bridge, in the Lake District the bridge is put on the bottom right-hand third. It would have been wrong to have put the bridge in the middle of the painting.

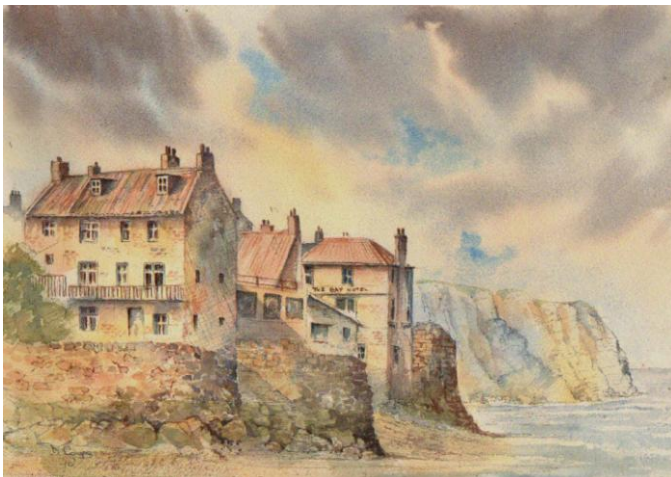

Here the centre of the building with the triangular shadow can be classed as the focal point and it is situated on the bottom left and third. If it had been positioned anywhere else in the painting lots of detail would be lost.

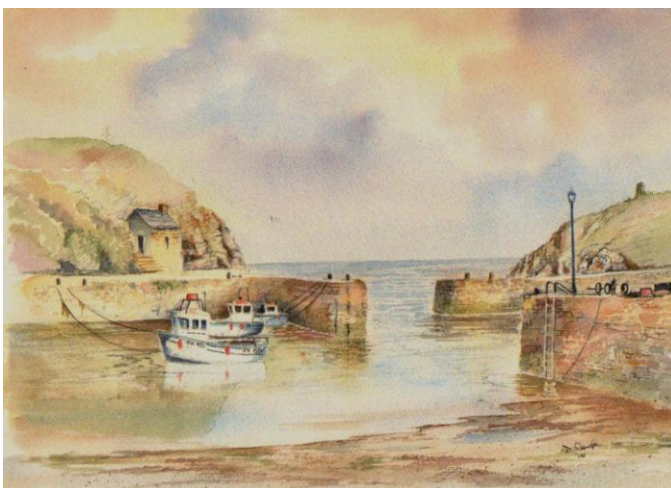

The focal point in the painting are the boats and the bottom left-hand corner, but it could quite easily be the meeting points of the two jetties because of the contrast in that area.

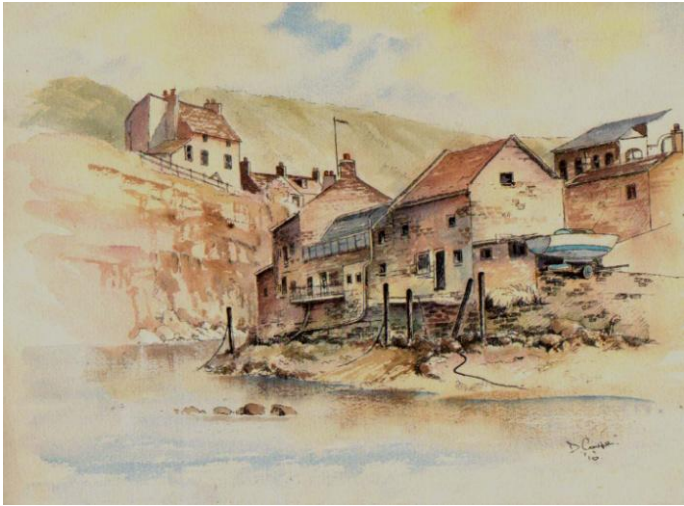

In this one the focal point could be one of two, the contrast of the end of the buildings against the light rock face or the blue of the boat.

Just moving one or two meters either side can make a massive difference. I've done it myself, having finished the painting and packed away all my gear, I had started walking away from the scene I immediately saw a better one.

While out painting in the landscape I have often seen many perfect dry stone walls, so perfect I have knocked them down and put holes in them (not actually, the farmer wouldn't let me) to give the walls interest and break up the perfect shape, a thing we don't often want. Too many straight parallel lines in a picture, especially landscape is not good for the composition. If I said to somebody, 'draw me a river running through a field' what I would get would be two straight parallel lines. For a start because of perspective the lines would never be parallel and you would never get just a line for a river bank. A river bank normally has muddy slopes or grasses and weeds alongside and the only time you see a straight line is when a river is in flood. So avoid dead straight lines and don't use a ruler when sketching. It is much better to draw everything freehand, even buildings look much better if the lines aren't perfect, especially the apex of the roof which looks much better with a bit of sag, but only in the picture, not in real life.

So there we are, they are the basics of watercolour painting, I hope I've done it in a way that you have found easy to understand. If not, just go through it again until you're happy and understand what I have been saying. I have painted for approximately 52 years and still find it extremely enjoyable and find that when I am painting time just flies by. But the important thing is I am still learning.

I don't think I will ever get to a point where I am not working on my painting. There is always something new to discover and explore, be it water control or a certain way

of using a certain brush. There is always something new, that is the beauty of watercolour painting. But number one is don't get discouraged and enjoyed the process not the finishing of a painting, which many see as being the ultimate goal. Not for me, painting is the important part, even getting up early in the morning and spending a couple of hours practising skies, trees or figures it is all part of the process.

The important thing is to enjoy your painting and don't get discouraged if it takes longer than you thought it would, because it will. If you have any questions about any of the subjects in this book please don't hesitate to get in touch through my website at <http://www.watercolourartist.net> and I will try to help as much as I can.

You can either e-mail me or if you would like to talk to me directly please phone and I would be only too happy to discuss your problems. If you would like a more practical way you could join my two hour weekday lessons or a Saturday workshop. The main thing is to get lots of practise not just once a week, more like once-a-day. It is the only way to achieve your aims. Many students say that they just do not have the time, and yet, if I ask 'what do you watch on the TV' they will run of a whole string of programs, such as Eastenders, Corry or Big Brother, surely they would be better off painting.....

Happy Painting,

David Coupe

